

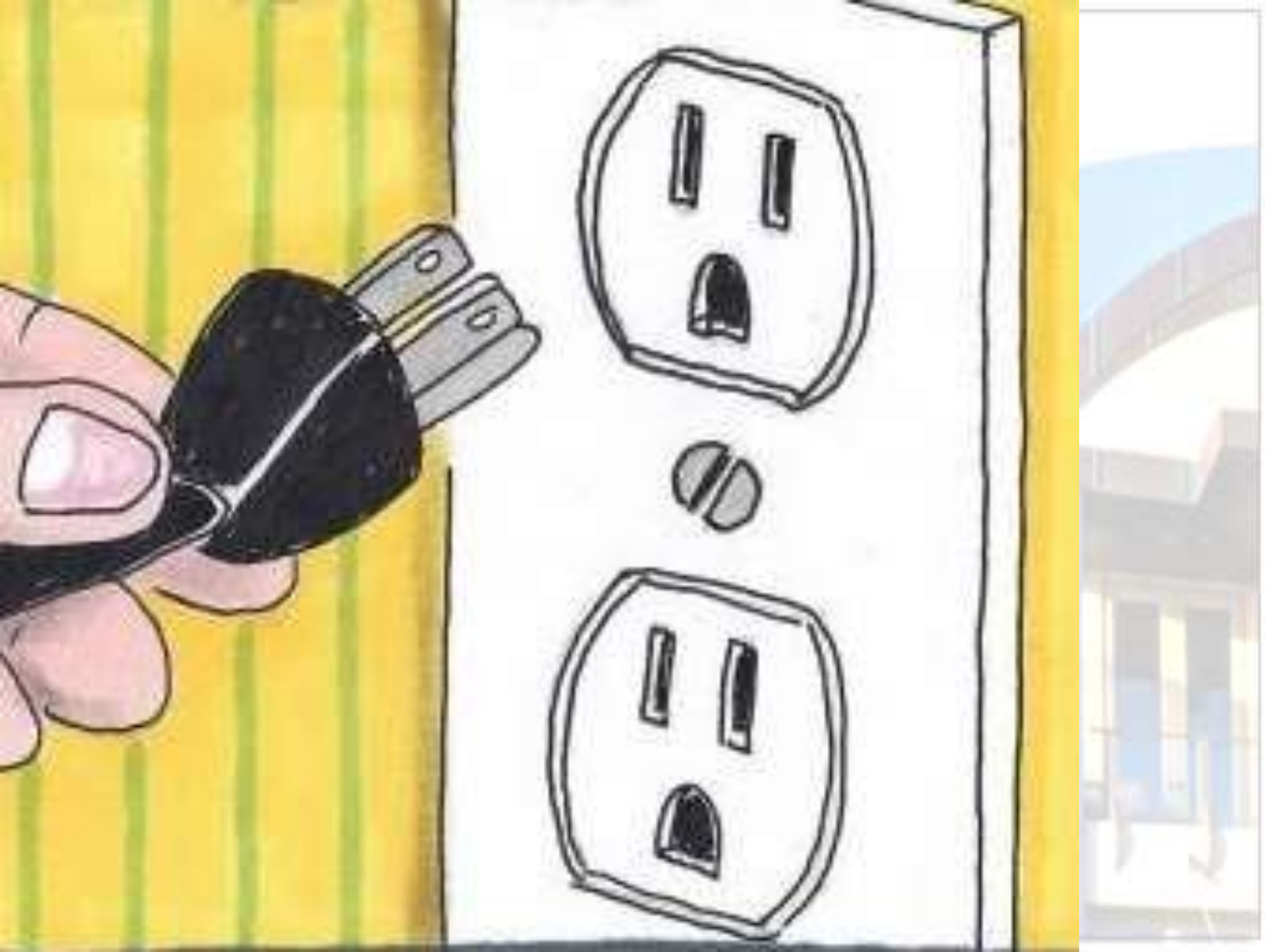

**Inverted Demand Compliant  
Construction (IDCC),  
a Key to a Renewable Energy Future**

**Myron Katz, PhD  
Building Science Innovators**

EEBA Conference 9/23/14  
St Louis, MO



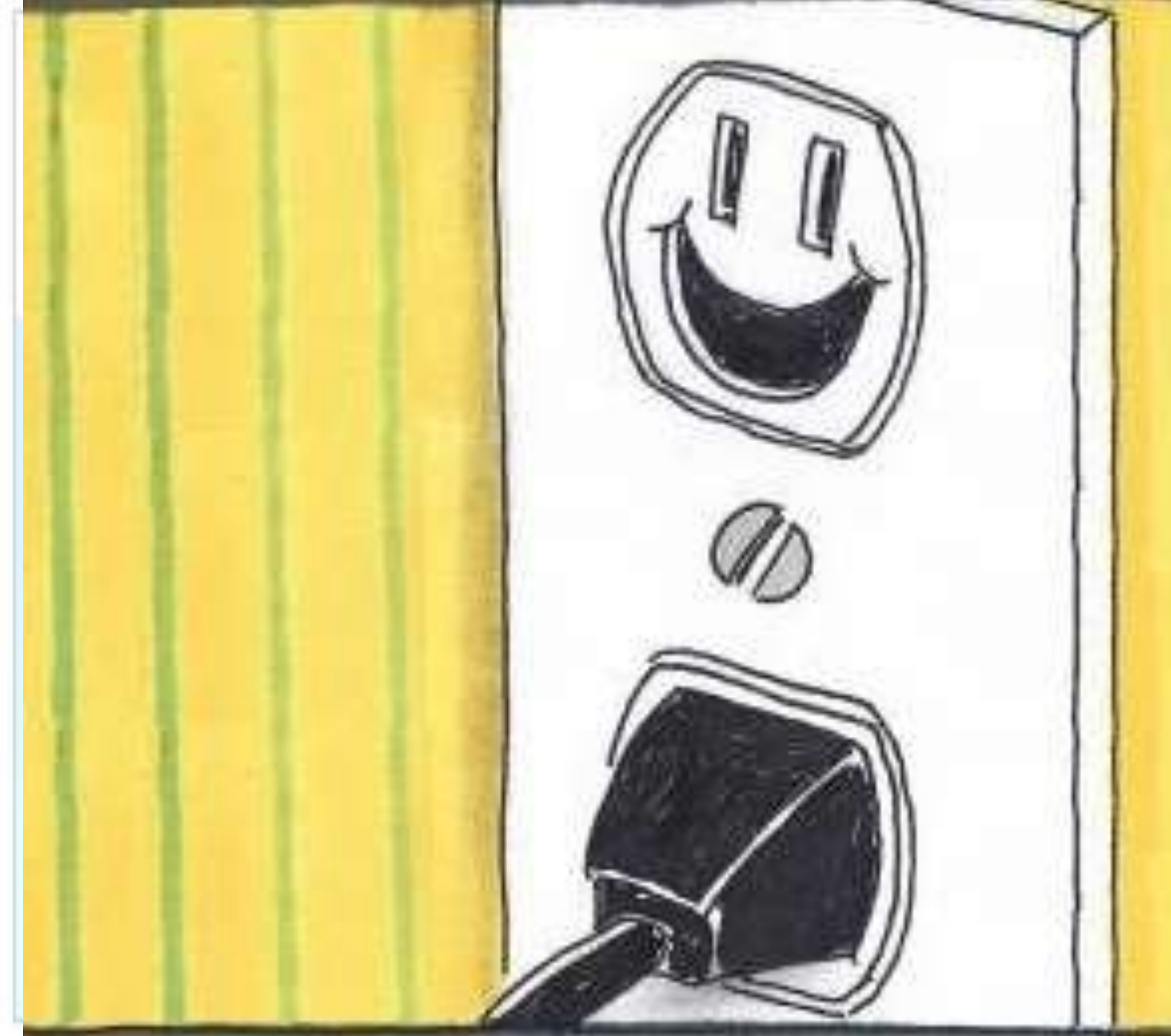

# ***Conceptually, Inverted Demand Compliant Construction (IDCC)***

*means*

1. “Electricity Demand vs Time” of a building is as atypical as possible when compared to most other buildings, hence ***Inverted Demand***;
2. Demand for electricity by the building and Supply of electricity to the utility is ***Compliant*** to requests made by the utility; and
3. ***Construction*** states that this specification is for the consumer’s side of the meter.



# Typical Demand During a Day

Home electricity usage reaches a peak between 3pm-7pm on hot days

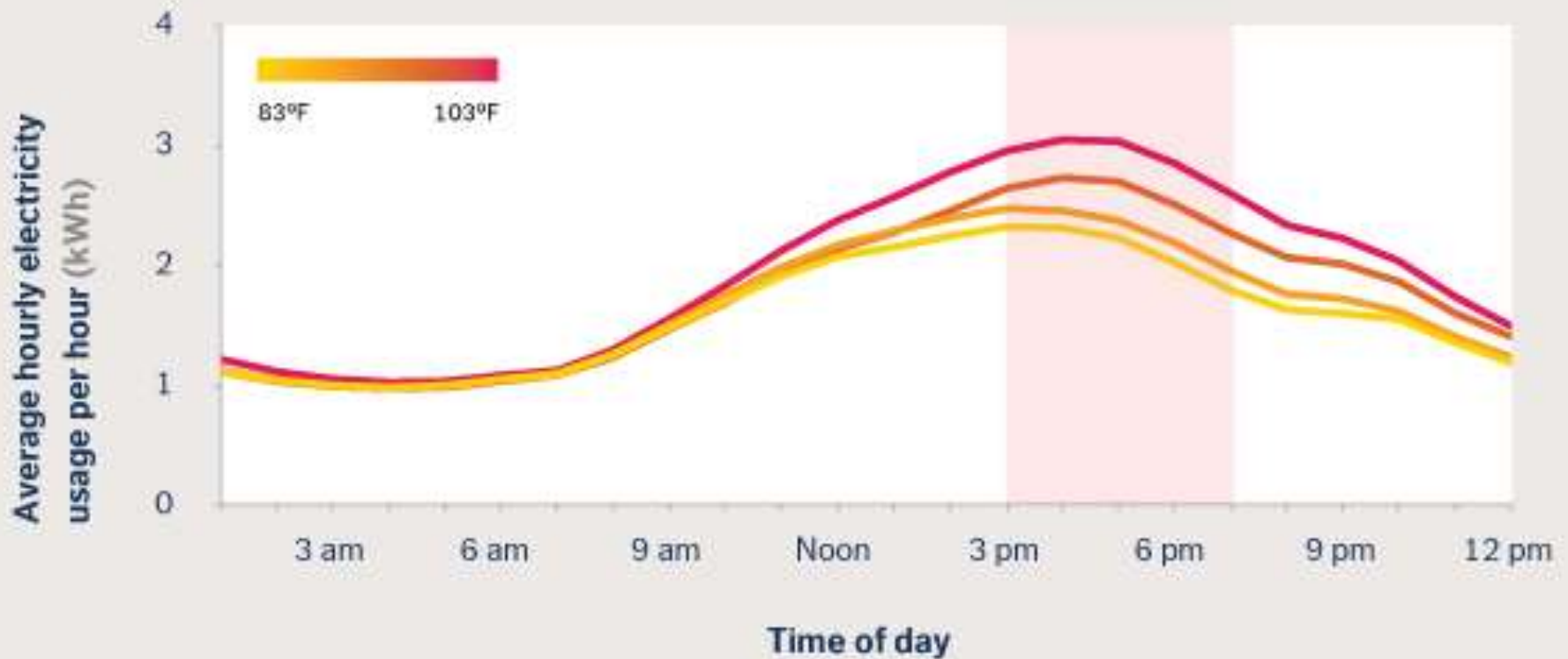



# Atypical Demand During a Day

Home electricity usage reaches a peak between 3pm-7pm on hot days



# **A Building has Inverted Demand when it:**

- Completely avoids demanding power from the grid when the wholesale cost of electricity is high;
- Uses no on site fossil fuels for making electricity;
- Includes an electricity storage device (ESD) (e.g., battery bank with inverter), large enough to provide all of the power and energy needed for one day's unfettered electricity consumption on the most demanding day of the year, and can be recharged between 1 and 5 AM.

# What is an IDCC Building? It

- Has **Inverted Demand**, and
- Is **Compliant** to requests by the grid operator, i.e.,
  - Provides ***Demand Response***, i.e.,
    - Decreases demand on request of the grid operator, and
  - Provides ***Supply Response***, i.e.,
    - Allows charging and discharging of the battery storage to be under the control of the grid operator.



# Why IDCC? It

- Provides a grid-connected specification for a hybrid, battery-backup & full-time power supply.
- Easily absorbs non-dispatchable renewable energy.
- Saves money for the building owner and utility.
- Designed to store low cost electricity.
- Improves electricity reliability.
- Produces less CO<sub>2</sub> , and
- Pays back as well as PV.

# Organization

1. IDCC's gets value from both sides of the meter.
2. Coupled to a revolution in grid design, IDCC greatly improves reliability & lowers cost.
3. IDCC enhances PV penetration and is easily exported to the developing world.
4. IDCC pushes building science to help buildings coast from 5 AM to 1 AM.

*What is offered here is a new perspective for energy professionals, one that will increase our effectiveness and achieve greater benefit to the consumer, the utility and society. Although it redefines **energy efficiency**, it is not that radical, and it better aligns all parties in a common effort to minimize environmental impacts; it more clearly focuses our efforts upon **reducing fossil-fuel consumption**.*

— Michael Holtz



**Change tracks!      Change the goal from**  
***Energy efficiency, i.e., using fewer kWh***  
**to**  
***Energy conservation i.e., generating less CO<sub>2</sub>.***







**The need for  
Reliability makes  
Backup Power  
Economical Now for  
many buildings;  
perhaps those that use  
most of US electricity.**



# Fossil-fueled Backup Power was Ruled Out



# Fossil-fueled Backup Power was Ruled Out

- **Can be dangerous**
- **Has an unreliable fuel source**
- **Difficult to maintain**
- **An outside eyesore, weather beaten, in the way**
- **VERY, VERY NOISY!!!**
- **Half as efficient compared to utility generators**
- **Has no “in Home” energy conservation incentive**
- **Has no tax subsidy**
- **Provides less reliability to my outlets**
- **Provides no potential benefit *FROM* or *TO* the utility when there is no power outage**
- **Has no way to promote the greater task of reducing CO<sub>2</sub> production of the grid**

# Emergency Backup Mode

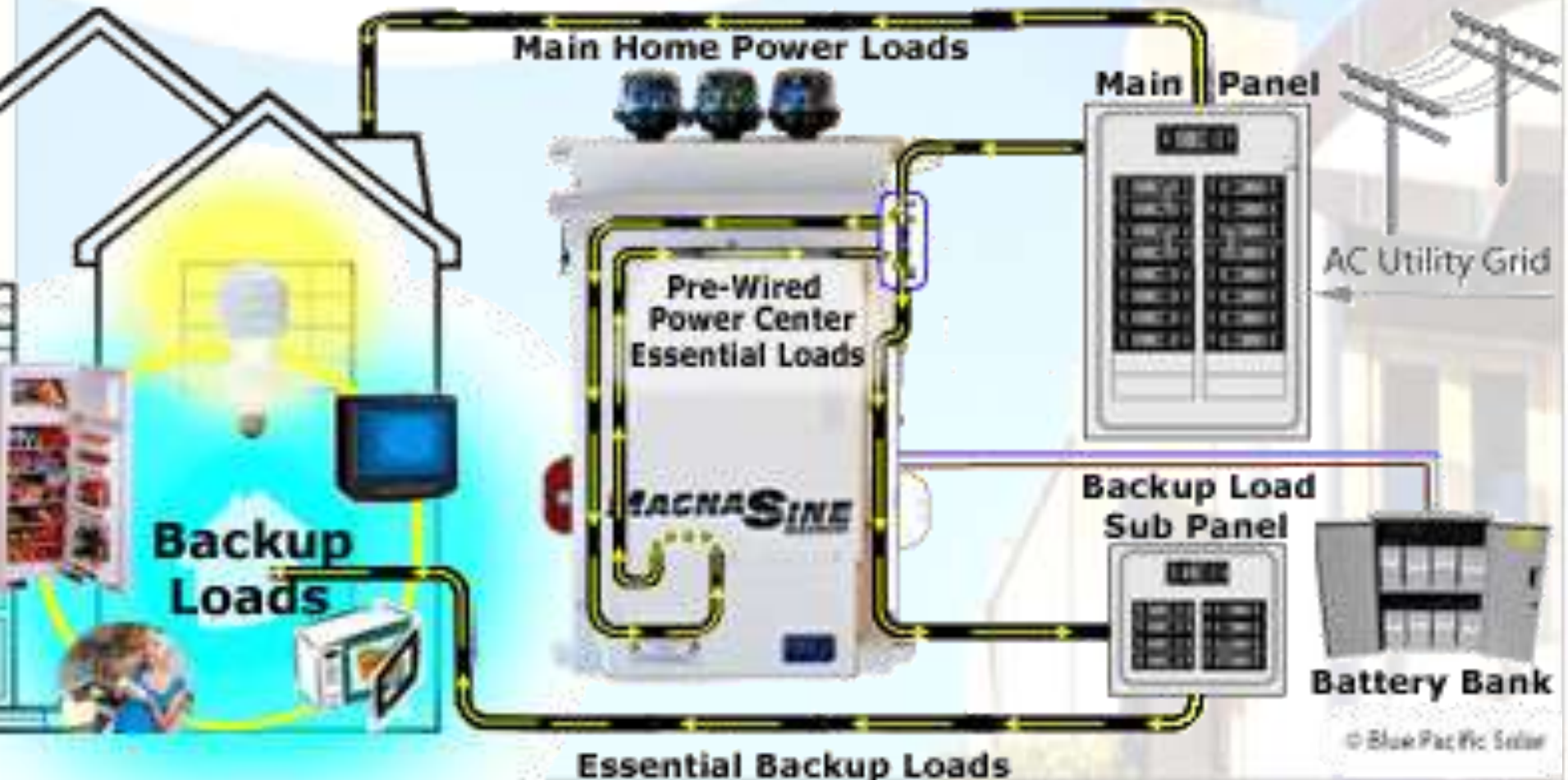

# **Part 1**

**Inverted Demand Compliant Construction (IDCC)** receives value from both sides of the meter.

# Implementing Inverted Demand

All current buildings can rapidly effect Inverted Demand by installing a battery and inverter/charger system that takes 4 hours to collect all of the energy that a building consumes in 24 hours.



**Less than \$5000 is sufficient.**

Using AGM batteries, one can install a battery backup and inverter/charger system that will make a New Orleans home Inverted Demand.



# My Energy Storage System



# 8 Advanced Glass Matt Batteries





$$234 \text{ AH} * 12 \text{ volts} = 2.8 \text{ kWh}$$



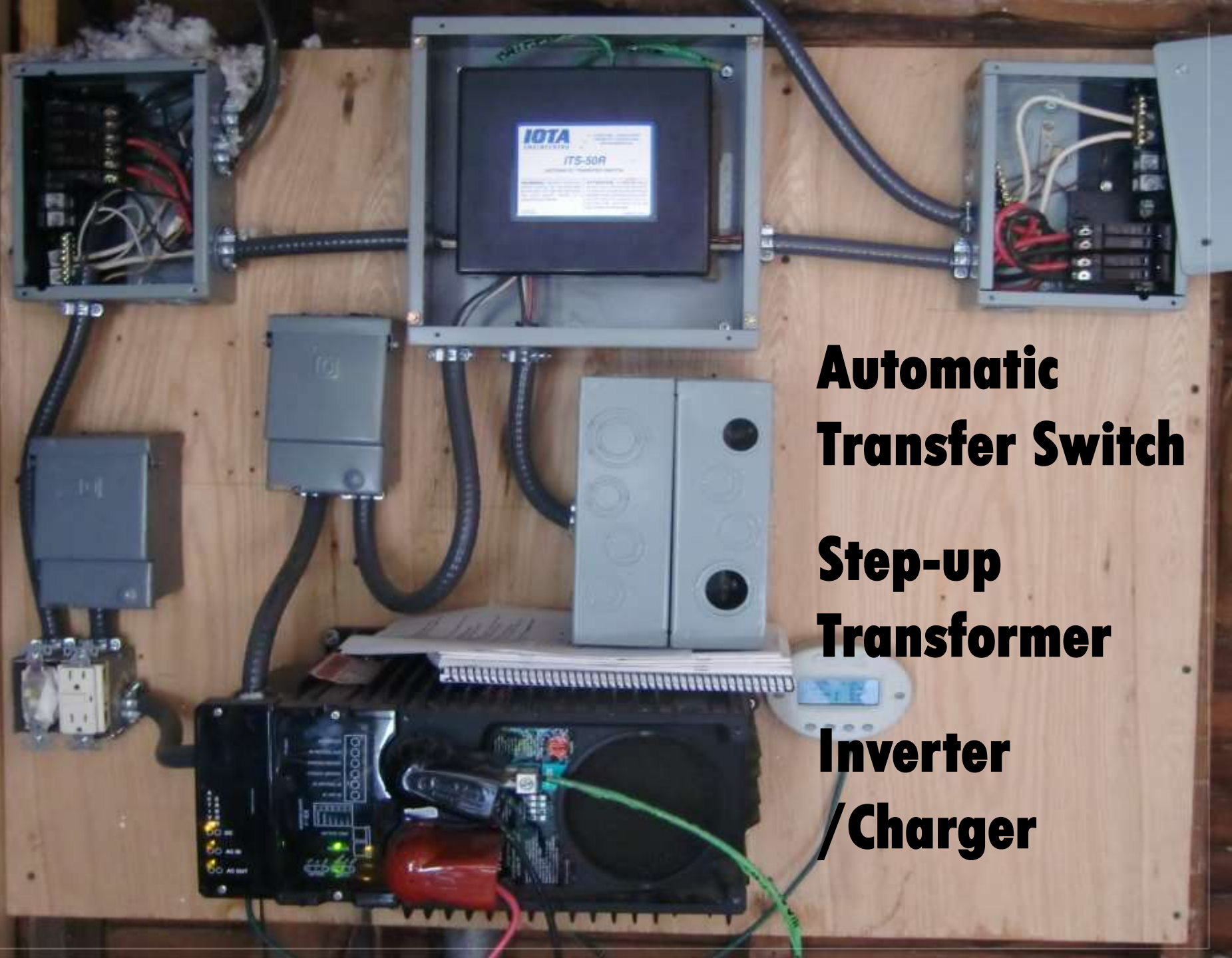

**Automatic  
Transfer Switch**

**Step-up  
Transformer**

**Inverter  
/Charger**



# Energy Storage Installed Costs\*

Inverter / Charger	4 kW	\$1500
Transformer	4 kW	300
Automatic Transfer Switch		50
AGM Batteries	20 kWh	<u>3000</u>
Total		\$4850

\*Eligible for a 80% in tax credits because of my lone solar panel!

# SolarCity's *much* Smaller Footprint



# Reliability

- What does it cost the utility?
- What does it cost the consumer?
- How do these costs help pay for IDCC?

# **Pepco Threatened by Poor Reliability**

Maryland Public Service Commission fines

Pepco \$1 million

December 21, 2011

“Maryland regulators fined Pepco \$1 million Wednesday for failing to fix problems that have led to the frequent outages that have long plagued customers of the Washington region’s leading power company.”



# Blue Sky, Residential Outage Costs

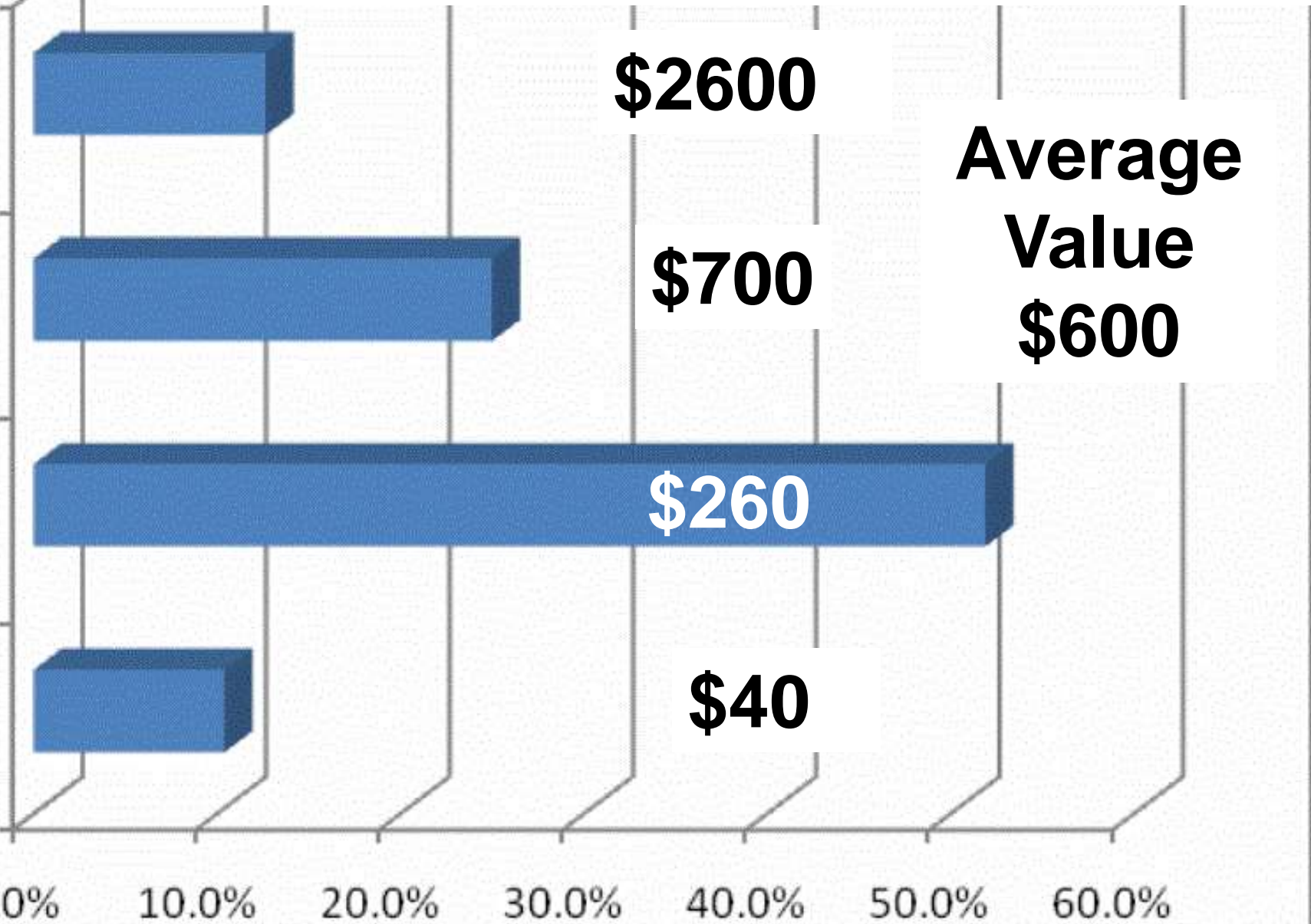

# Blue Sky, Commercial Outage Costs

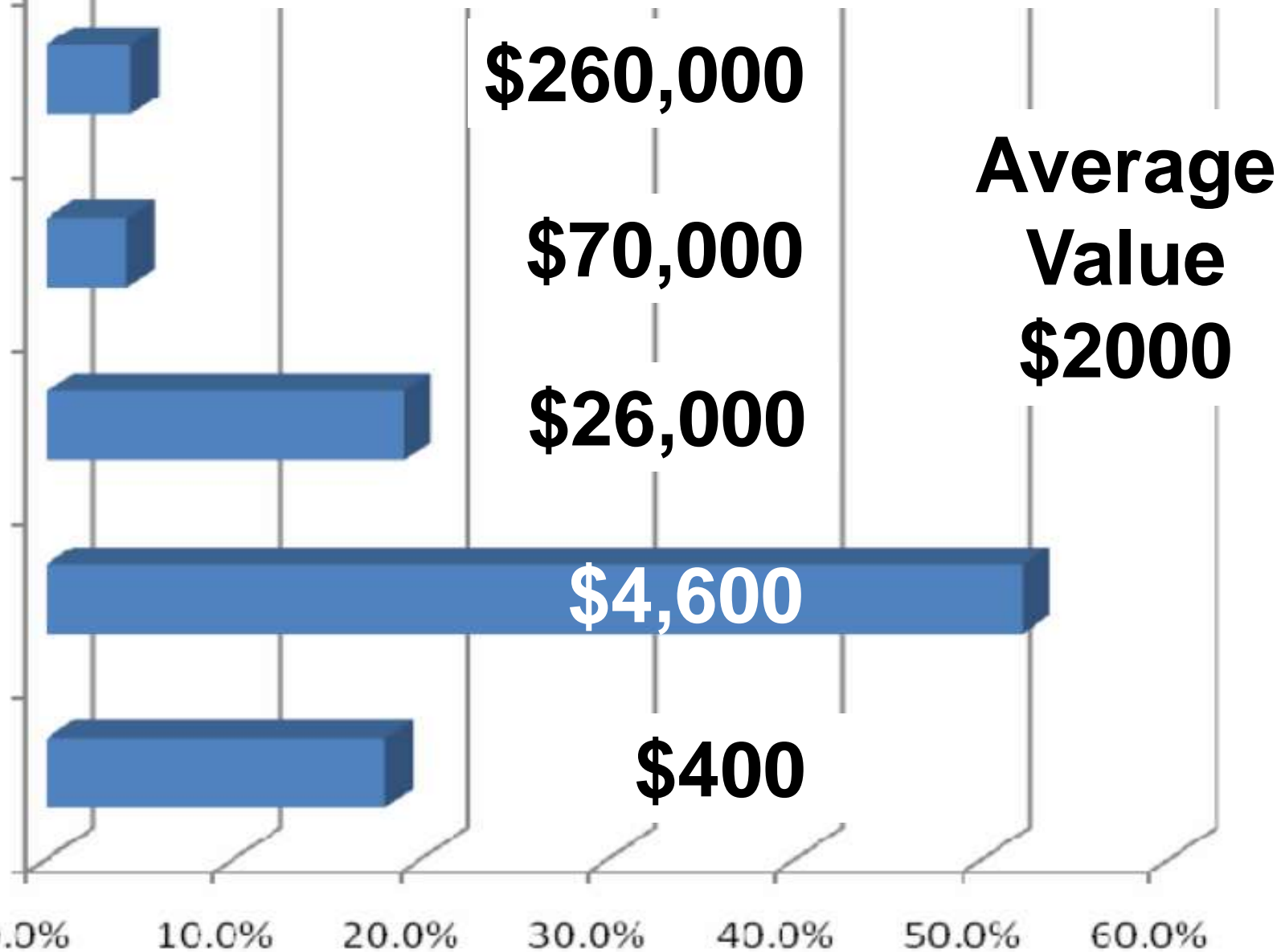

# How does Reliability Pay for IDCC?

Residential customers are often beset with fear:

Think: *Katrina, Sandy, or Polar Vortex.*

\$1500 to \$20,000 estimates damages for  
Outages that last a day to a few weeks.

Commercial customers report (i.e., Pepco data):

Outages are common without storm events;  
these last a few minutes to a few hours

\$20,000 in damage on average.

# Why Don't Utilities Install Batteries?

- During a recent public meeting of Integrated Resource Planning by Entergy New Orleans, I asked why batteries were not considered. I was told by their executives that they had been considered but were deemed not economical.
- I retorted that that can only be the case because they were not considering that batteries owned by retail customers provide the needed additional value -- derived from the enhanced reliability provided directly to those customers.



# What Pays for IDCC Besides Reliability?

Here are three ways that the utility *SHOULD* pay you money or give you a retail rate discount because your building helps the grid avoid expensive wholesale electricity.

- Demand Response
- Supply Response
- Frequency Regulation

# Demand Response

“Changes in electric usage by end-use customers from their normal consumption patterns in response to

- changes in the price of electricity over time, or
- to incentive payments designed to induce lower electricity use at times of high wholesale market prices or
- when system reliability is jeopardized.”

# Implementing Supply Response

The addition of a \$130, AXS Port Modbus/TCP Interface can upgrade Inverted Demand, to IDCC since it provides “supply response”.

Charging and discharging are put under the REAL-TIME control of the utility.



# Frequency Regulation

A New Jersey, IDCC building may be allowed to sell this service to their wholesale power market, PJM.

“Regulation” protects electricity frequency. The following V2G example points out that if IDCC uses an 18 KW inverter/charger and a 24 kWh battery, such a building may receive income at \$5/day.



# **Grid on Wheels of V2G**

## **\$5 per car per day.**



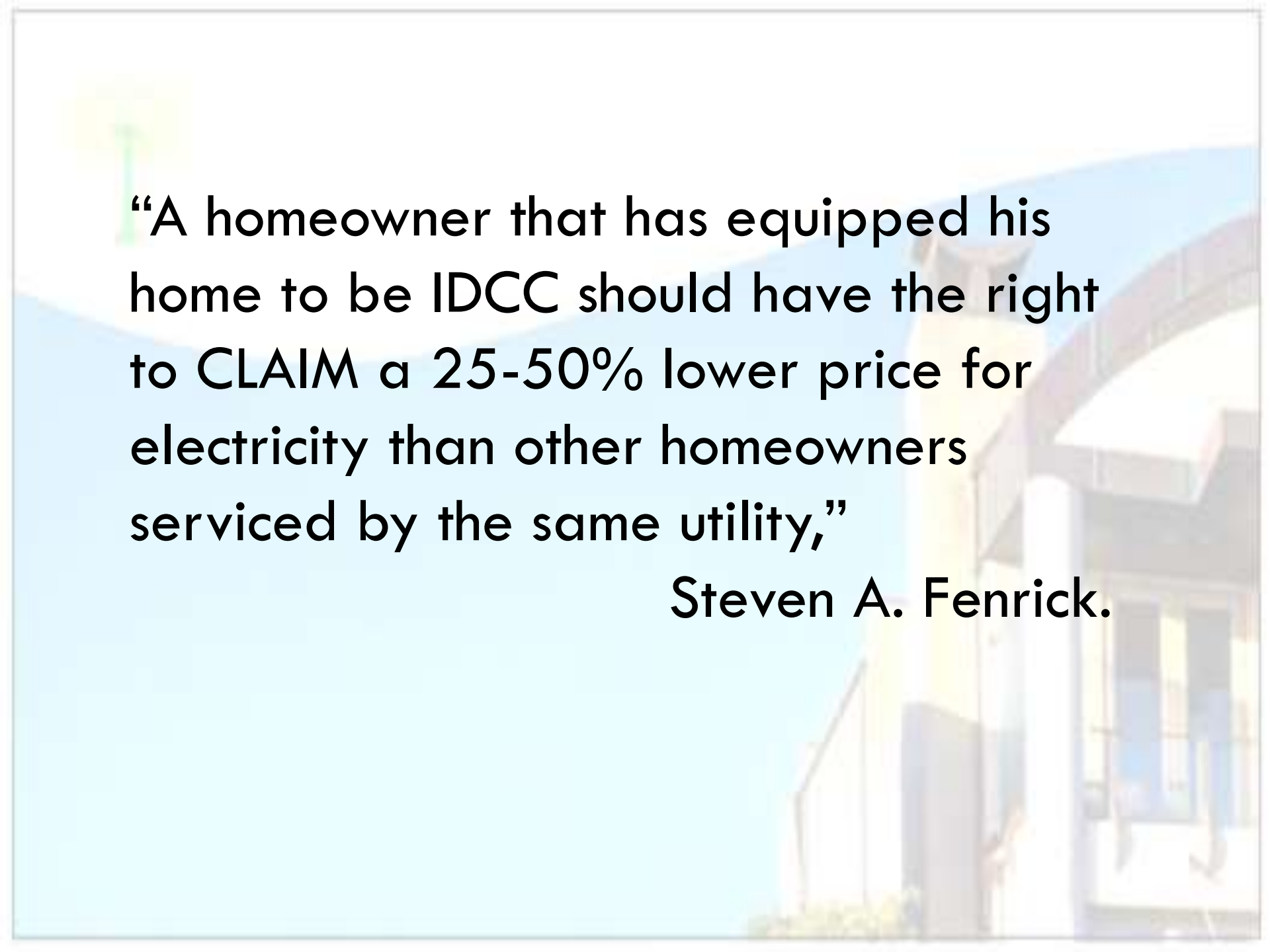

**“A homeowner that has equipped his home to be IDCC should have the right to CLAIM a 25-50% lower price for electricity than other homeowners serviced by the same utility,”**

**Steven A. Fenrick.**

# Critical Peak Pricing (CPP)

- High price in a focused time period during select days.
  - Ratio of CPP to off-peak prices can be as high as 10

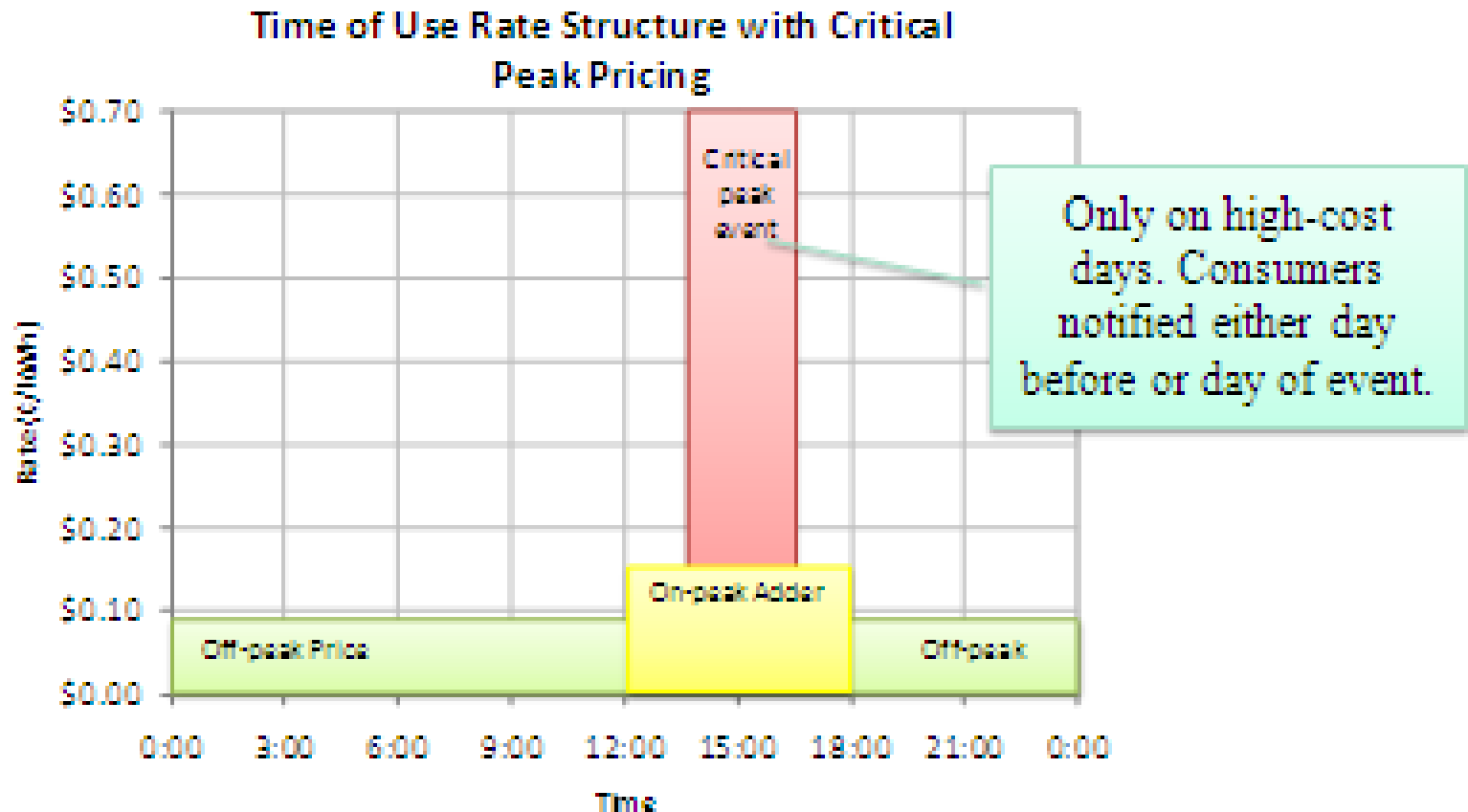

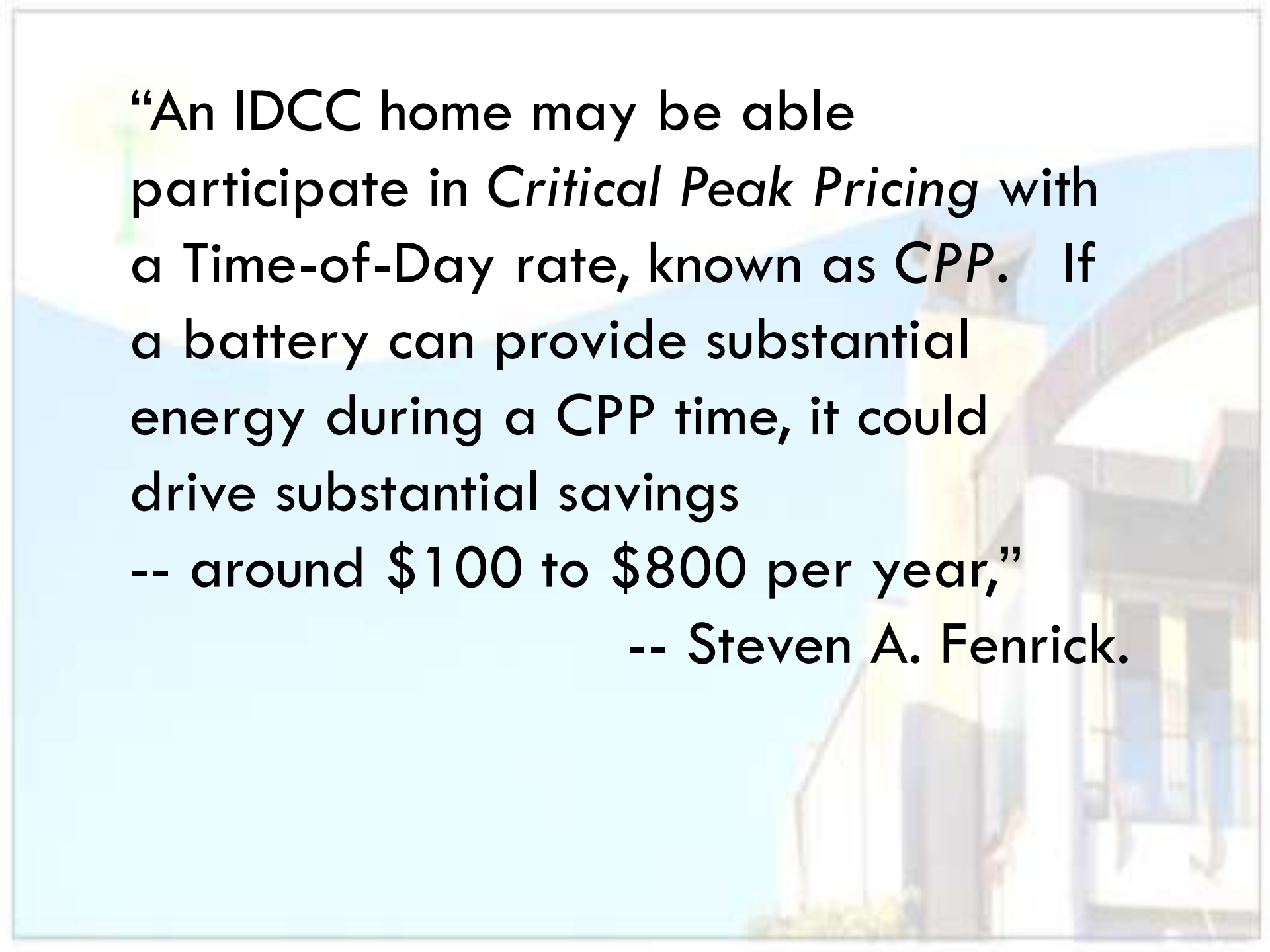

“An IDCC home may be able participate in *Critical Peak Pricing* with a Time-of-Day rate, known as *CPP*. If a battery can provide substantial energy during a CPP time, it could drive substantial savings -- around \$100 to \$800 per year,”  
-- Steven A. Fenrick.



# **IDCC is as Economical as PV**

Using 25 year simulations, I found IDCC to have about the same Internal Rate of Return as Photovoltaics over a wide range of assumptions. That is, both investments are about equally worthwhile.

# Internal Rate of Return - over 25 Years:

Jan-2012 Investments -- Biased **For** PV

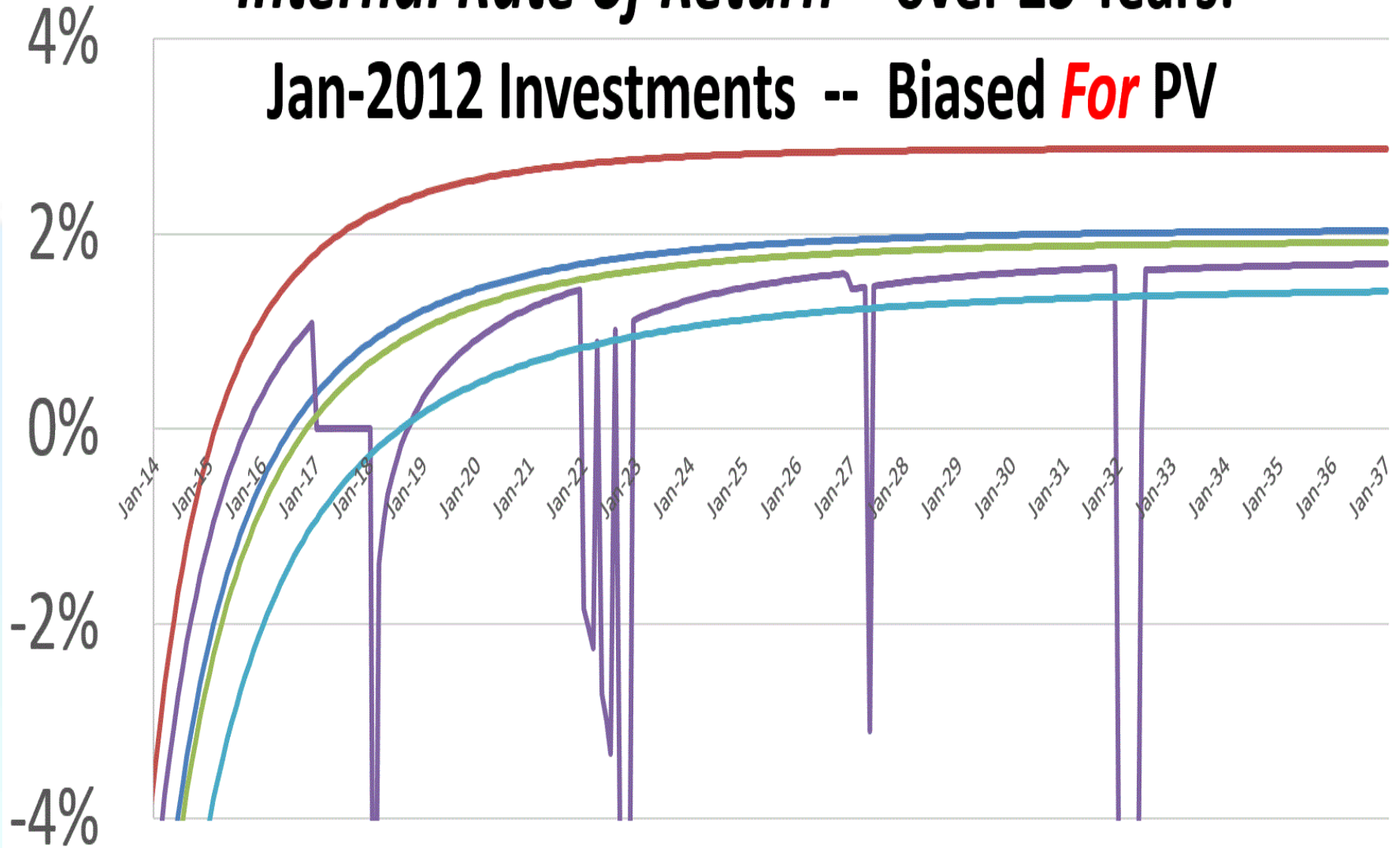

Utility Disc

Reliability

IDCC

V2G - Regulation

PV

# **In Part 1 you learned**

**Inverted Demand Compliant Construction (IDCC) is a cost-effective battery backup/ power supply specification which can receive two streams of economic value – each from opposite sides of the electric meter.**

Q 2 W S T O N ?





# **Part 2**

**Coupled to a revolution in grid design, IDCC greatly improves reliability & lowers cost.**

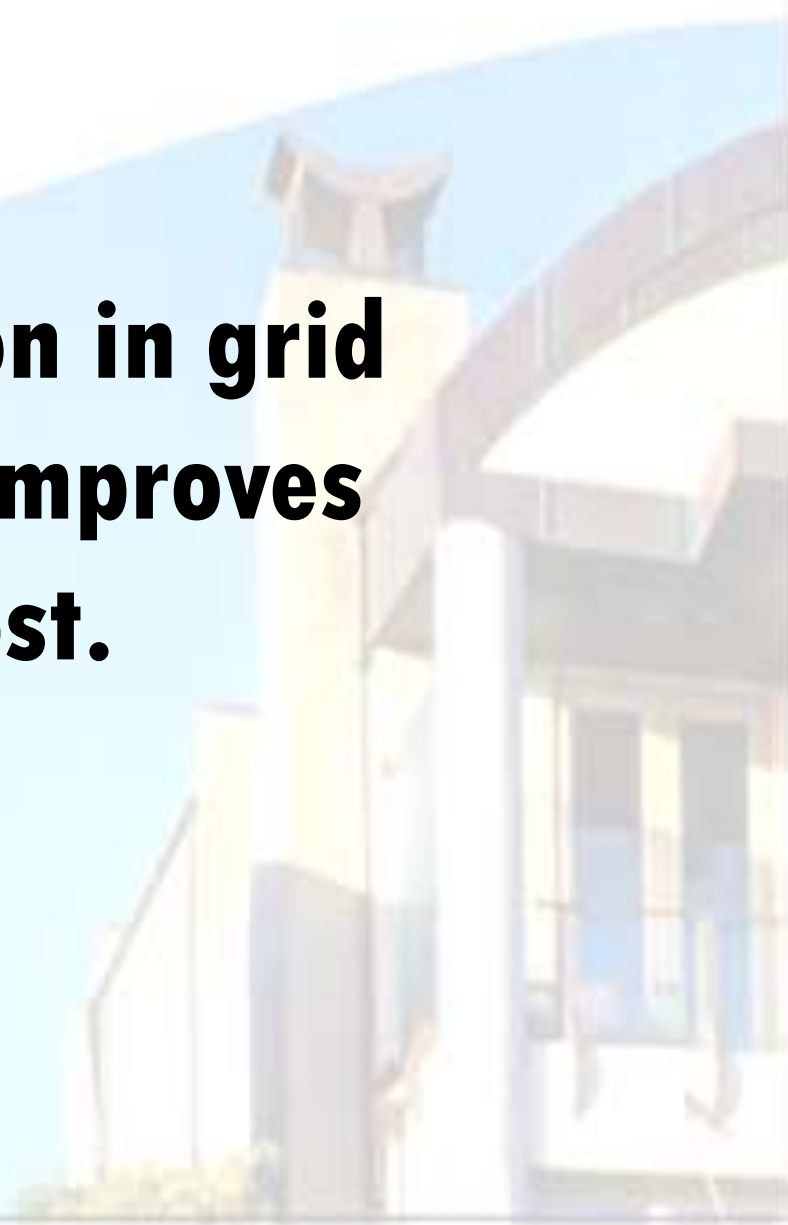

# Economic Dispatch IS



# Economic Dispatch IS NOT





**1¢/kWh**

**25¢/kWh**

**MISO on  
09-10-14  
@18:10**

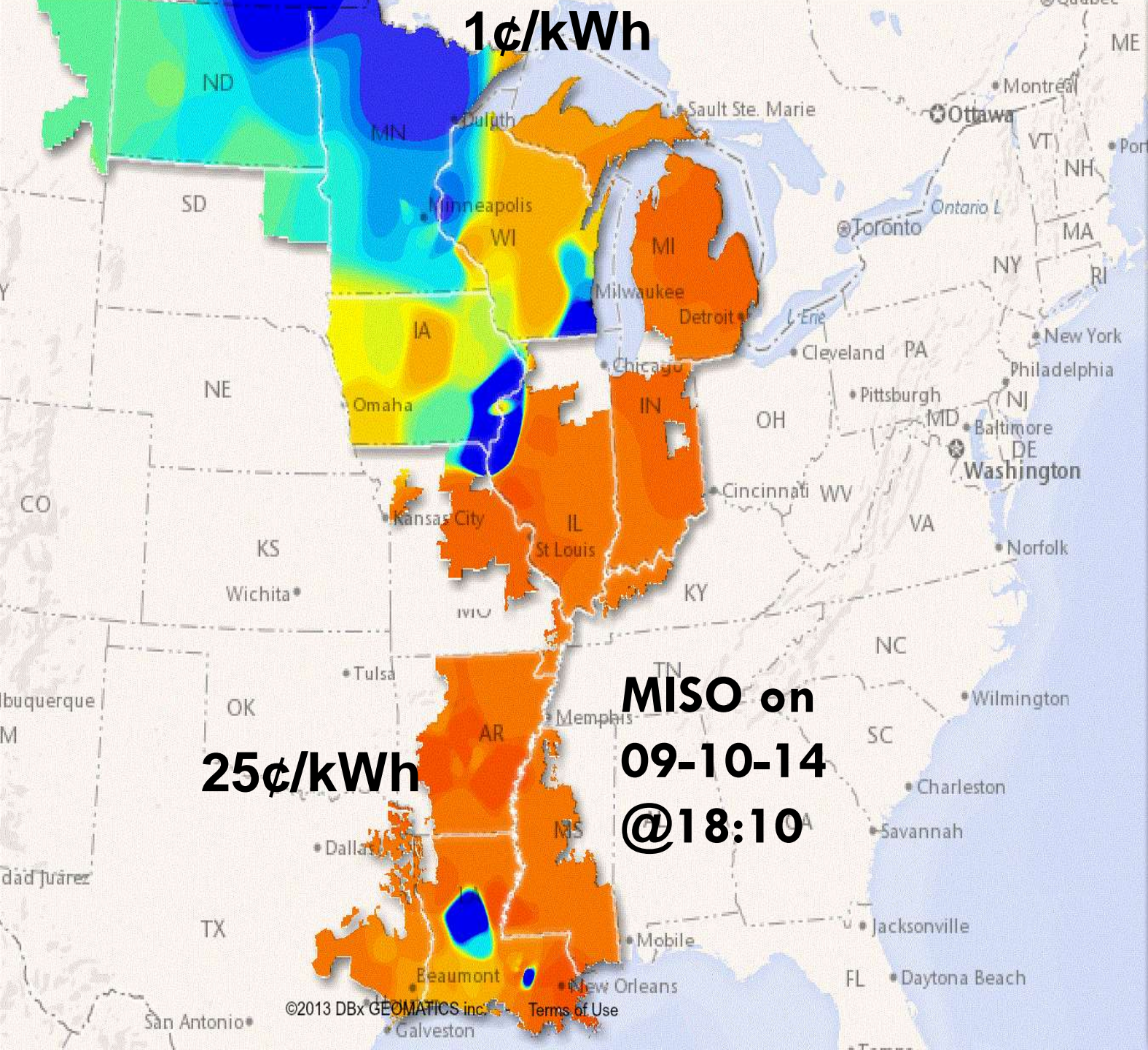
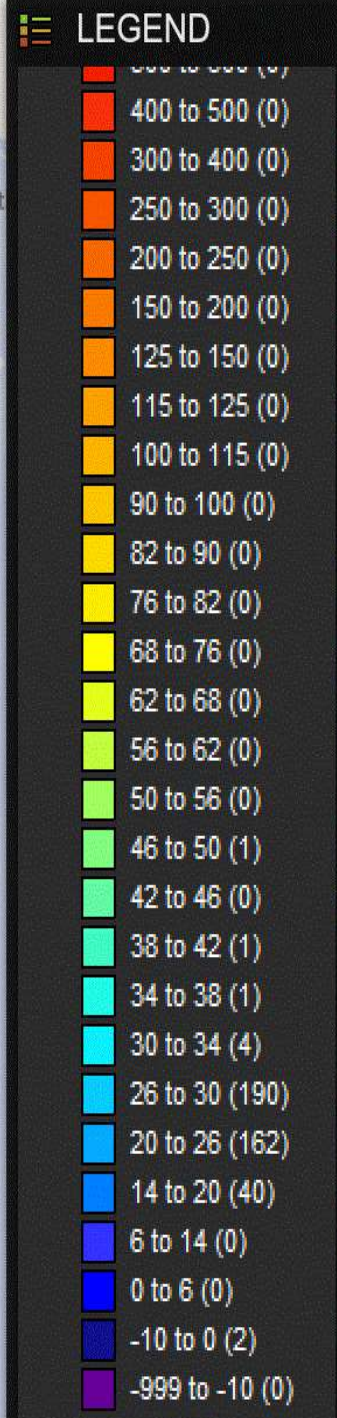



If there were no power losses from transmission and unlimited transmission capacity, there would *NEVER* be *ANY* geographic variation.

The condition “almost no geographic variation” actually occurs almost every day: at around 3 AM.

The temporal variation, i.e. between 3 AM & 6 PM, is major because the electricity generators charge much more money per kWh at 6 PM than 3 AM!



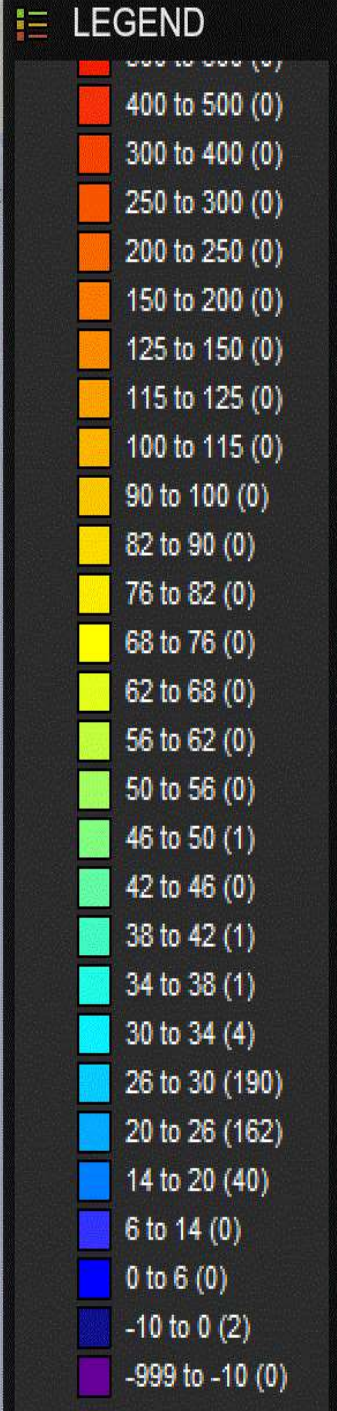
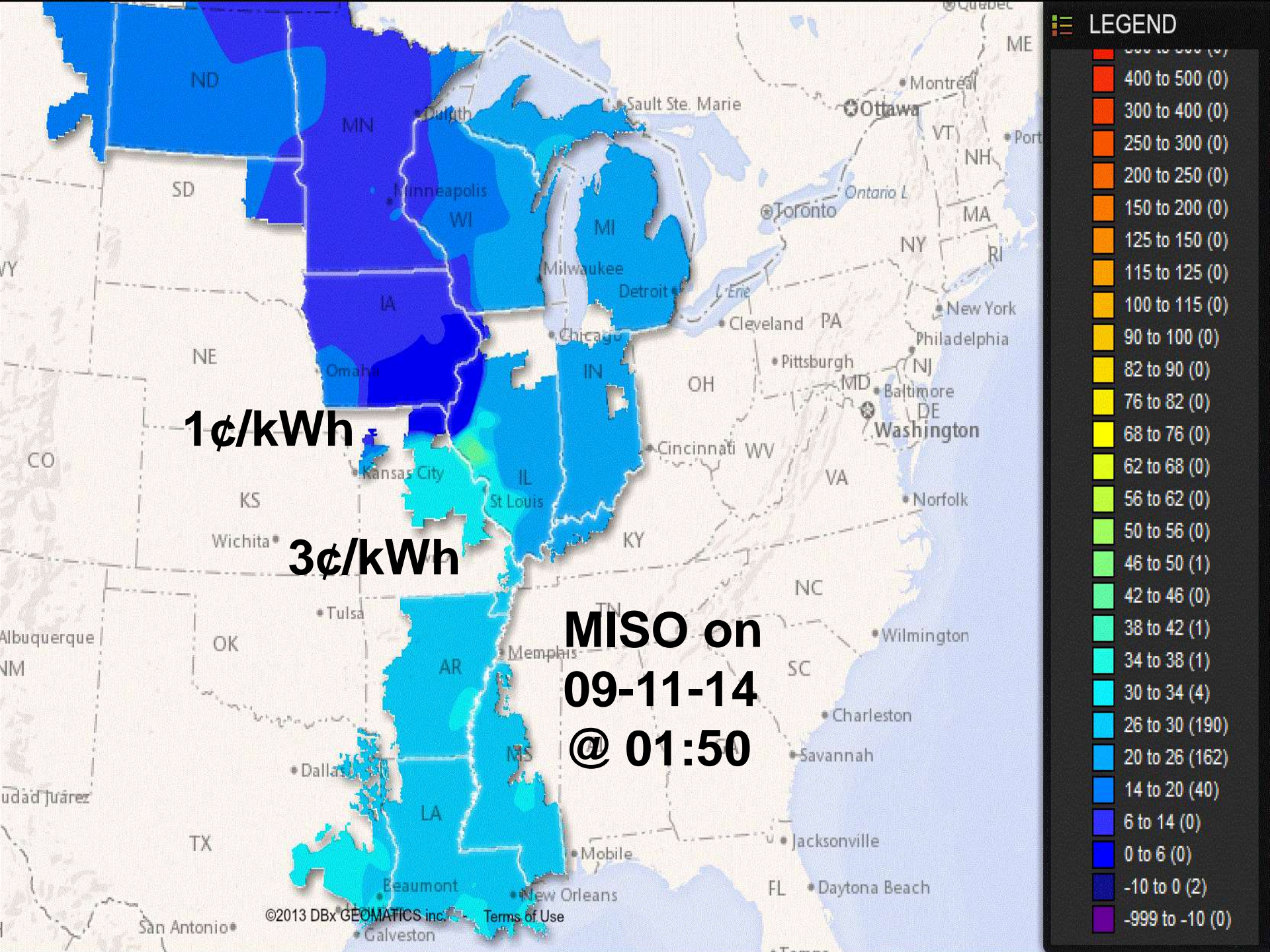

**1¢/kWh**

**3¢/kWh**

**MISO on  
09-11-14  
@ 01:50**



- Energy waste increases with the ***WHOLESALE*** price of fossil-fuel powered electricity.
- Therefore, if ***RETAIL*** electricity prices closely track ***WHOLESALE*** prices, a great deal of energy can be saved and CO<sub>2</sub> avoided.



- **Energy conservation *INCREASES* when the *utility* pays *MORE* for renewable energy.**

- Because ***DISPATCH*** undermines the wholesale price paid for renewable energy, ***ENERGY CONSERVATION CANNOT BE ADEQUATELY ENCOURAGED WITH RETAIL PRICE SIGNALS.***





As long as dispatch dominates the  
wholesale electricity market,

those who finance wind farm  
installations will continue to get  
depressed price signals

leading to less WIND investment.

# What is the Cost of Dispatch? Part A

**“What is the cost to society caused by the 100+ year old decision to dispatch power on demand?”**



***OR***

**“What is the cheapest way to have the electric outlet on the wall behind you function *ALL* the time?”**

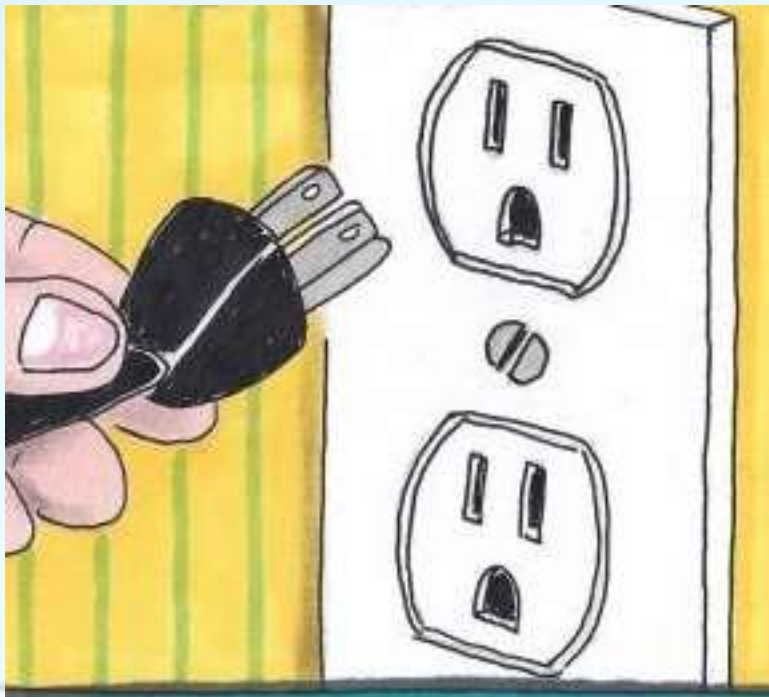



**Buildings *Without***

**Diapers**

We should not  
be designing  
buildings that  
dump demands  
onto the grid  
without regard  
to time-of-day.

We do  
not want  
infant  
buildings;  
we want  
mature  
buildings!



# Electricity 1.0

This is the utility design of the developed world.

It has done a very good job at integrating three things: providing reliable electricity 24/7/365, voltage, and frequency.

That is precisely why, for over 100 years, we have been designing Buildings Without Diapers!

# Electricity 2.0

- improved by smart meters
  - micro-grids and
  - independent producers
- only responsible for the electricity distribution
- provides a marketplace for selling energy between multiple generators and loads.
- allows islands of reliability
- can then migrate rapidly and in an orderly fashion into full grid competence.

# Electricity 3.0

Let's define Electricity 3.0

- to have all of the features of Electricity 2.0, except:
- Electricity 3.0 need only have grid reliability four hours a day but it must have this functionality  
**EVERY DAY.**

# **Reliability at the outlet vs. Reliability of the grid**

**Distinguishes Electricity 2.0 *from* Electricity 1.0.**

Electricity 1.0 achieves reliability at the outlet by total reliance on reliability of the grid.

Electricity 2.0 allows reliability of the outlet to be independent of the grid but still attempts to maintain (at a now unnecessarily high cost), the same 24/7/365 reliability of the grid.



# **Electricity 3.0 recognizes that**

1. Reliability of the outlet is the primary goal.
2. Less investment in the grid is needed if there is complementary investment in buildings.
3. It probably costs much less to put diapers on buildings and switch to Electricity 3.0 than to maintain Electricity 1.0.

# ***Mature-Citizen Buildings are more than Buildings With Diapers; they***

1. Completely avoid buying expensive electricity
2. Use no fossil fuels for making electricity
3. Include a electricity storage/power supply, large enough to provide all of the power and energy needed for one day's unfettered electricity consumption on the most demanding day of the year, and can be recharged between 1 & 5 AM
4. Provide for Supply Response and
5. Use no fossil fuels for any purpose.

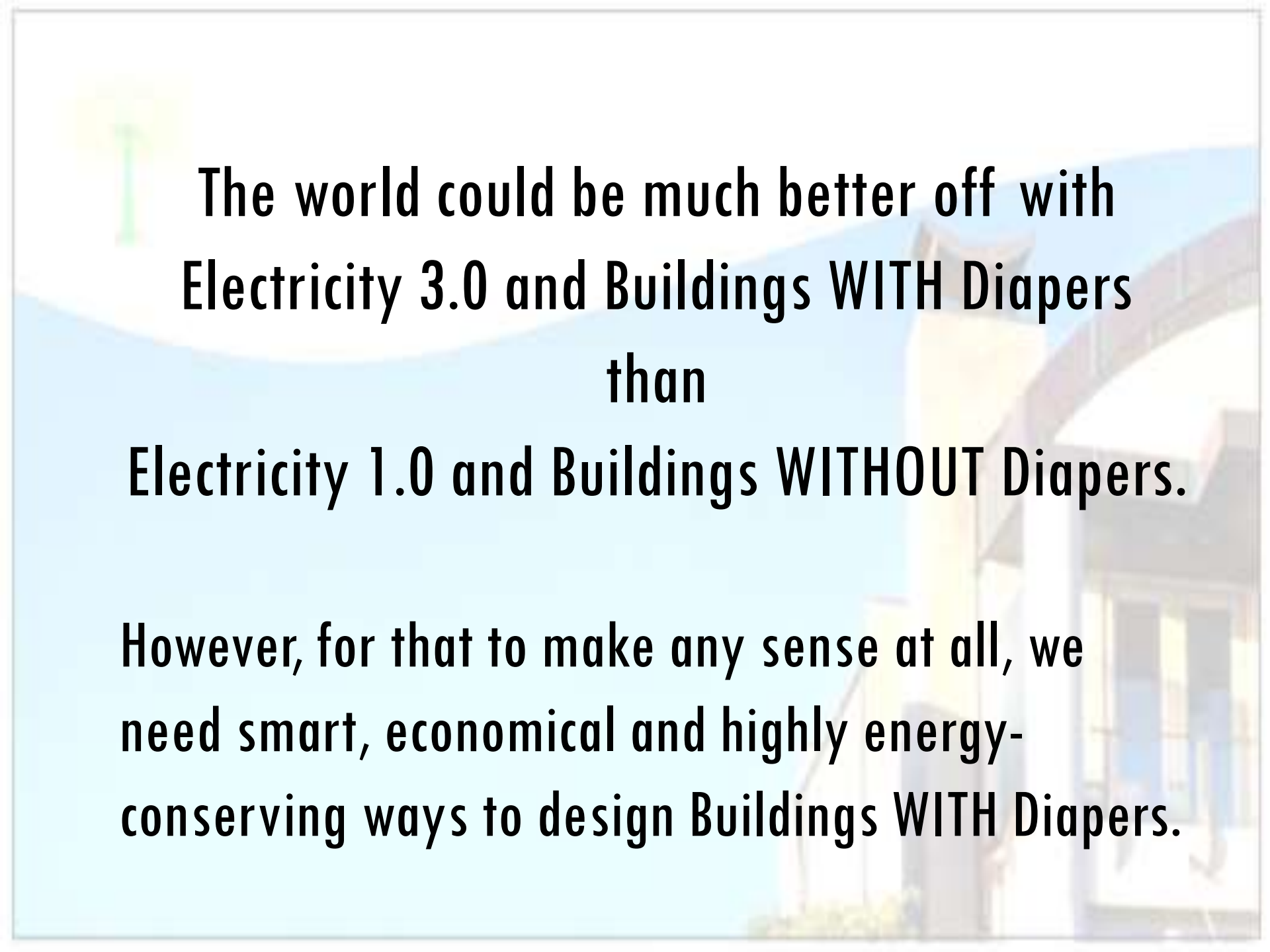

**The world could be much better off with  
Electricity 3.0 and Buildings WITH Diapers  
than**

**Electricity 1.0 and Buildings WITHOUT Diapers.**

**However, for that to make any sense at all, we  
need smart, economical and highly energy-  
conserving ways to design Buildings WITH Diapers.**

# **What is the Cost of Dispatch? Part B**

**We should scientifically compare two options:**

**Electricity 1.0 and Buildings without Diapers  
to**

**Electricity 3.0 and IDCC Buildings**

**using the following 2 metrics (or “yardsticks”).**

**I define the *Cost of Dispatch* to be the difference  
in the costs of the first and second option:**

- measured in Dollars.**
- measured in CO<sub>2</sub> produced.**

# **The Cost of Dispatch measured in \$**

may be as high as:

**50% of the retail price of electricity.**



**The Cost of Dispatch measured in CO<sub>2</sub> is very temporal.**

Although greatly impeded by Electricity 1.0, *Non-Dispatchable* renewable energy is rapidly penetrating the grid.

But, switching to Electricity 2.0 or 3.0 will greatly speed this up because they avoid many major and predictable roadblocks.

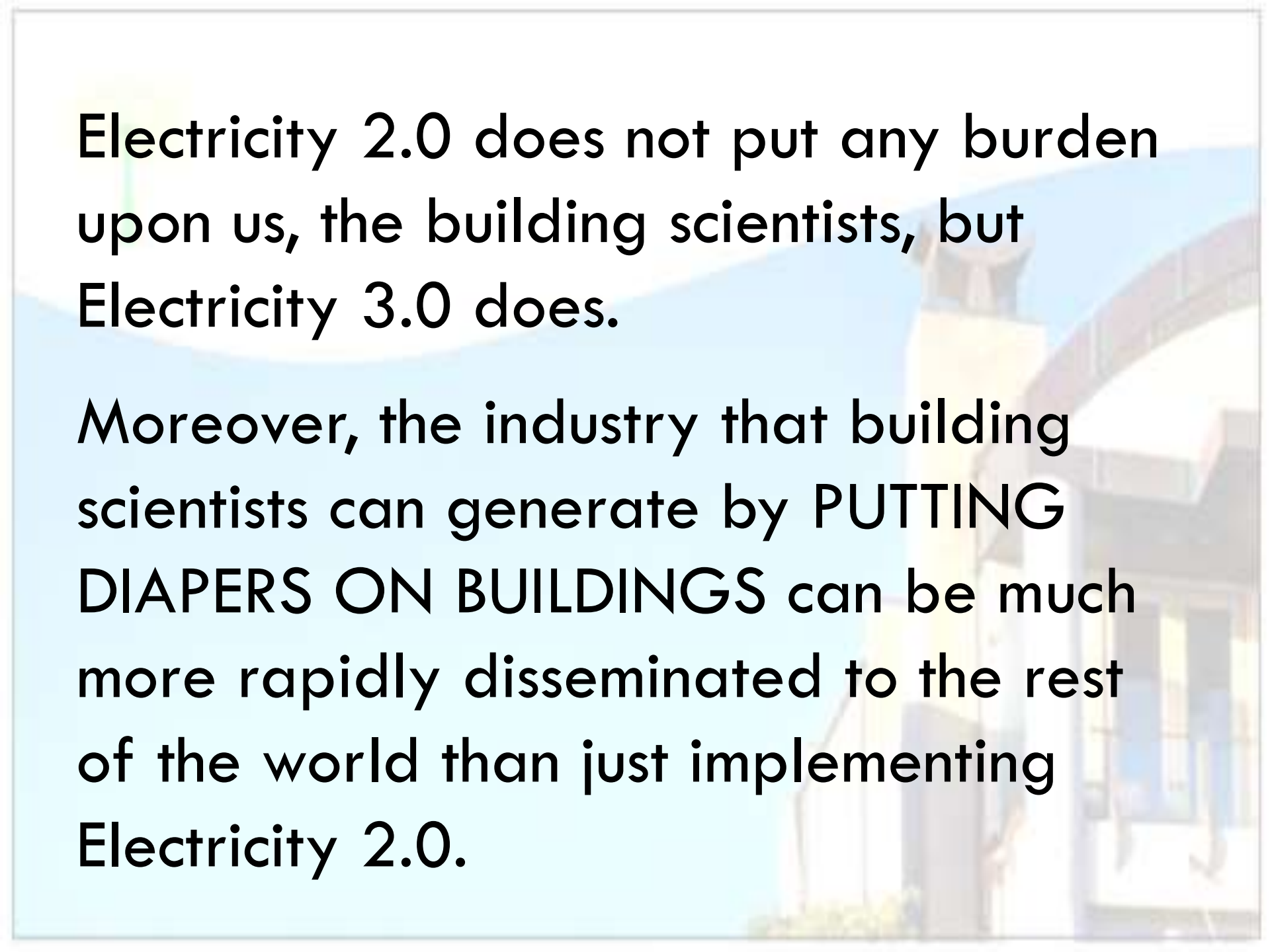
The background of the slide is a photograph of a building with a prominent archway. The building is light-colored, possibly yellow or cream, and the archway is a darker color, possibly brown or red. The sky is a clear, bright blue. The overall scene is brightly lit, suggesting a sunny day.

Electricity 2.0 does not put any burden upon us, the building scientists, but Electricity 3.0 does.

Moreover, the industry that building scientists can generate by **PUTTING DIAPERS ON BUILDINGS** can be much more rapidly disseminated to the rest of the world than just implementing Electricity 2.0.

# In Part 2 you learned:

IDCC complements *Electricity 3.0*,

- a potential revolution in grid design;
- dispatching power is deemphasized and
- the grid's job changes to providing a marketplace to accommodate daily **ENERGY** needs;

in turn, IDCC buildings provide reliable **POWER** to their own outlets.

Q 2 W S T O Z ?  
? 2 W S T O Z ?



# **Part 3**

**IDCC enhances PV and WIND penetration and is easily exported to the developing world.**





million Btu)

# U.S. Renewable Energy Supply

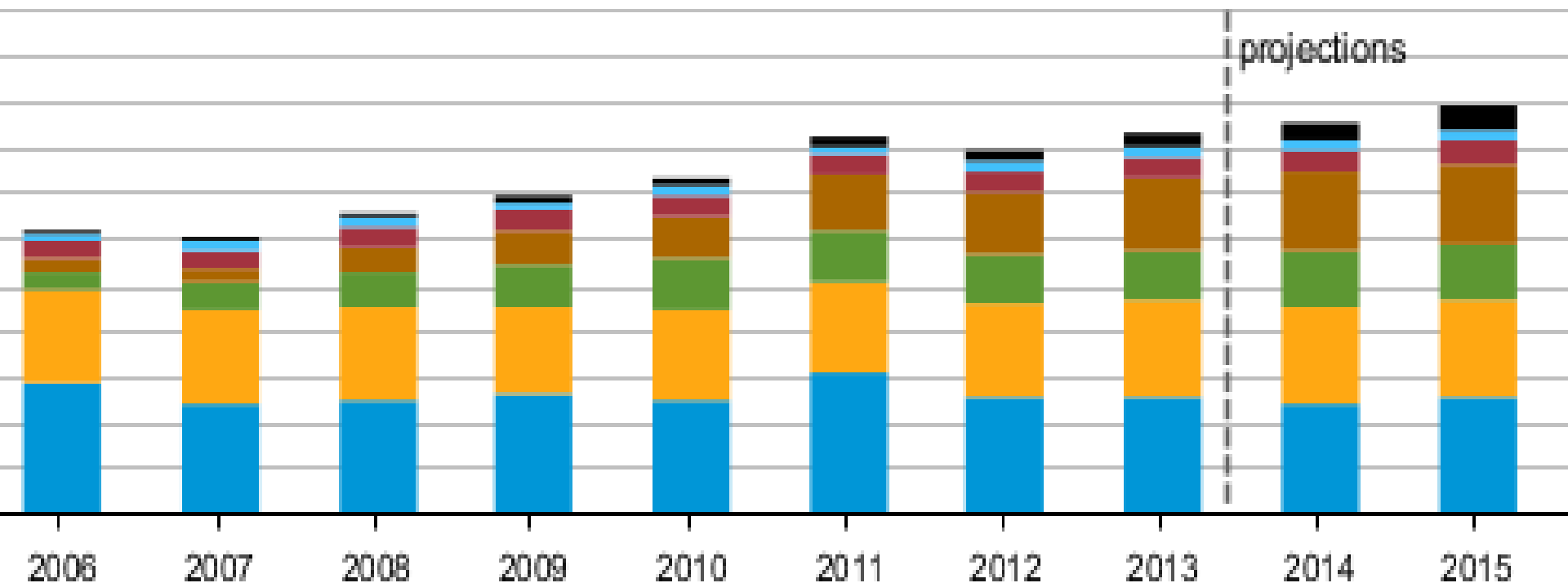

- Solar
- Geothermal
- Other biomass
- Wind power
- Liquid biofuels
- Wood biomass
- Hydropower



**What we are interested in today are  
the *Non-Dispatchable Renewables*.**

**Those are the ones we are in most  
urgent need of.**

**Without them a renewable energy (RE)  
future is impossible.**

**IDCC greatly improves the economics  
of these *Non-Dispatchable Renewables*.**

# U.S. Renewable Energy Supply

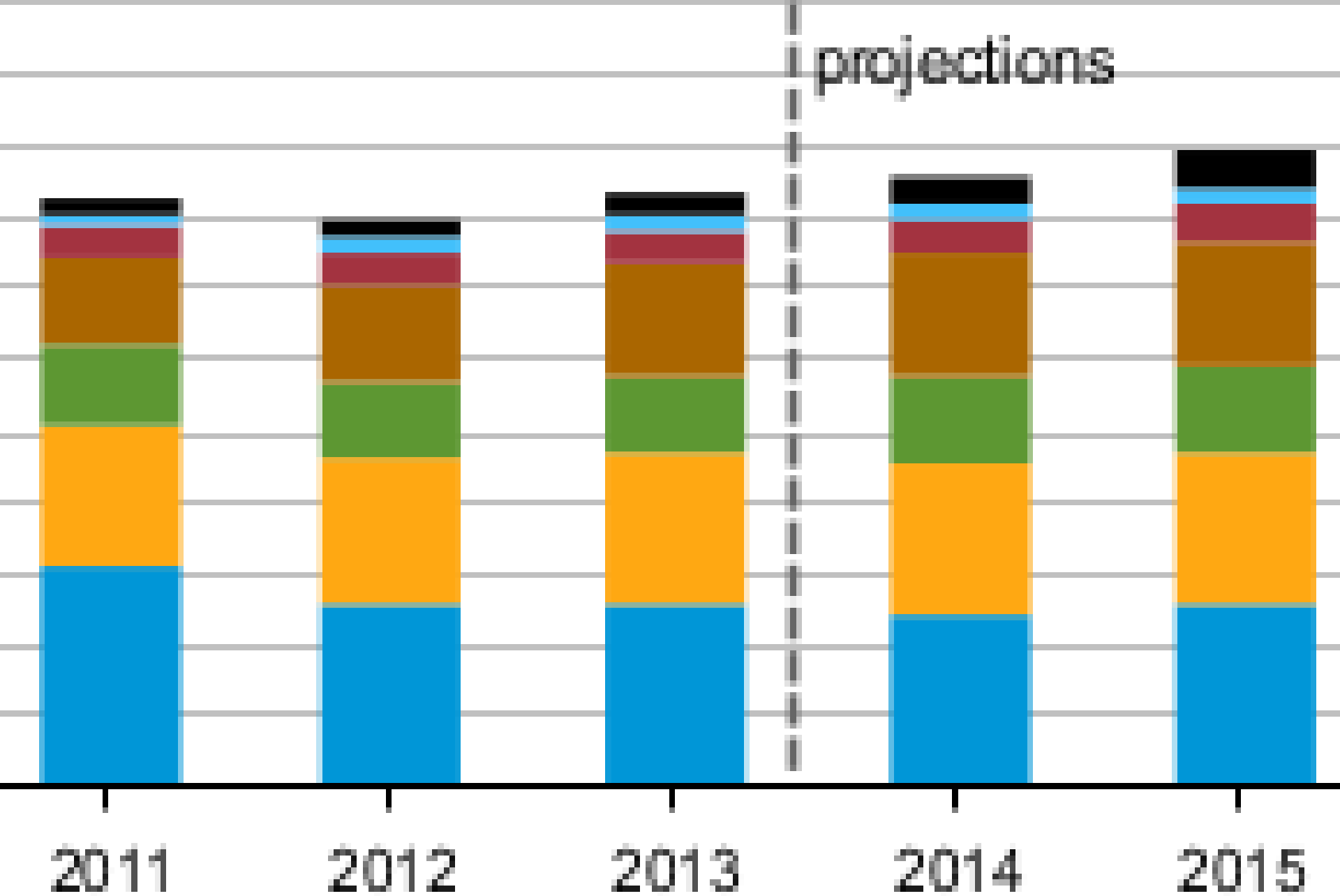

**Price and  
hamper Wind.**

**Transmission**



# **Low Prices Hurt Wind Development.**

August 2012

The Department of Energy said in a report last week ... it expects 2012 to be another strong year for new wind energy, but development of wind farms will dramatically slow in 2013. That's because tax credits that provide wind energy producers 2.2 cents per kilowatt hour expire at the end of the year.



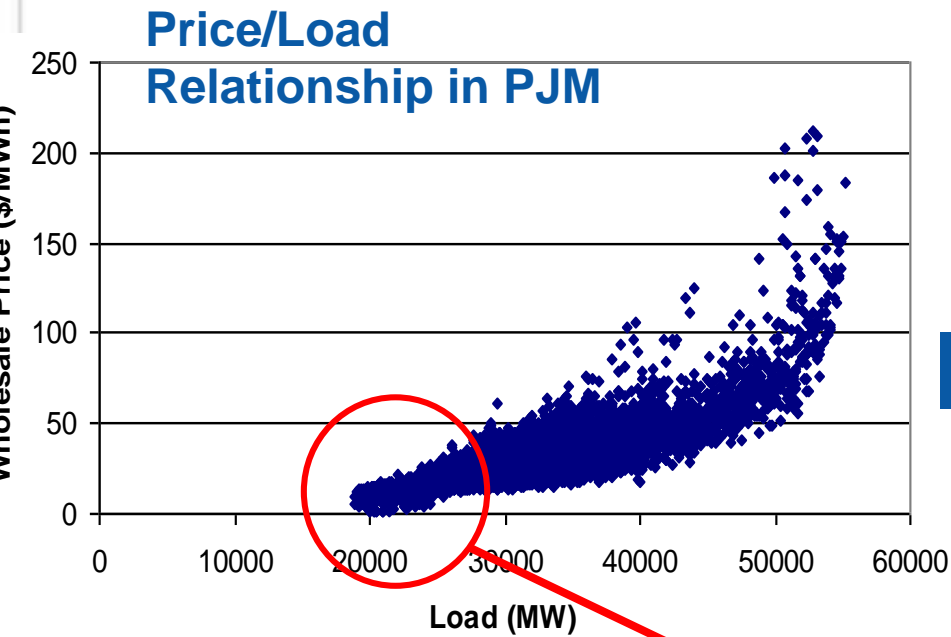

**Plant operators would rather sell energy at a loss than incur a costly shutdown.**

**Below Cost Bids**

**Wind is selling**

**@ < 1¢/kWh**

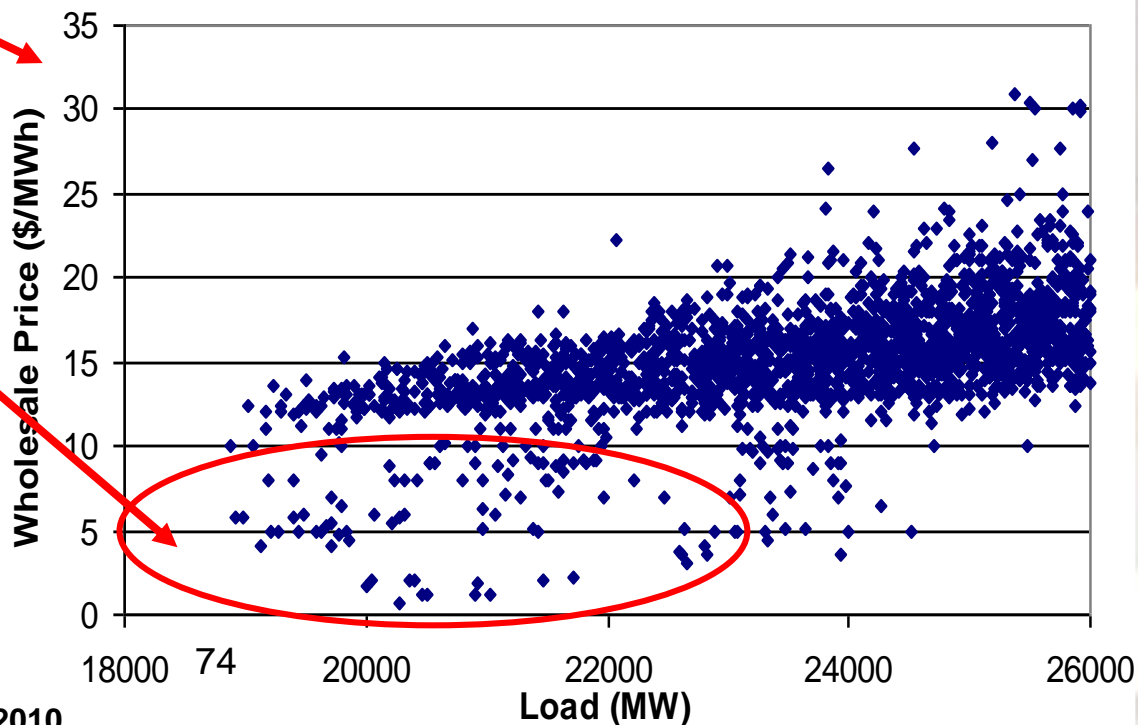

# Does WIND need more Transmission?

- As long as WIND must sell in a dispatching market, there will almost always be a mismatch between the amount of power generated and the “accessible” load. The greater the distance, the bigger the problem and therefore fewer loads of the grid are truly accessible.
- However, if WIND energy can be doled out much more slowly, i.e., by charging batteries at great distance from the generators, then most of this transmission constraint is avoided.

# Levelized Cost of Energy

is a prospective estimation of the *fixed* price at which electricity must be sold from a specific source to break even over the lifetime of the project. It is an economic assessment of the cost of the energy-generating system including all the costs over its lifetime: initial investment, operations and maintenance, cost of fuel, cost of capital.

## U.S. average levelized costs (2011 \$/kilowatt-hour) for plants entering service in 2018



It is hard for WIND to compete in the dispatching, wholesale marketplace, which have leveled costs below  $7.5\text{¢}/\text{kWh}$ .

PV can compete in the retail marketplace because it compares to energy priced above  $11\text{¢}/\text{kWh}$ .





# Sustainability Requires Solar Energy

“Within our lifetimes, energy consumption will increase at least two-fold, from our current burn rate of 12.8 TW to 28 – 35 TW by 2050 (TW =  $10^{12}$  watts). This additional energy needed, over the current 12.8 TW energy base, is simply not attainable from long discussed sources – these include nuclear, biomass, wind, geothermal and hydroelectric.” ... “Sunlight is by far the most abundant global carbon-neutral energy resource.”

-- Daniel G. Nocera, MIT



# PV has Decreasing Marginal Value

Marginal Economic Value  
(\$/MWh)

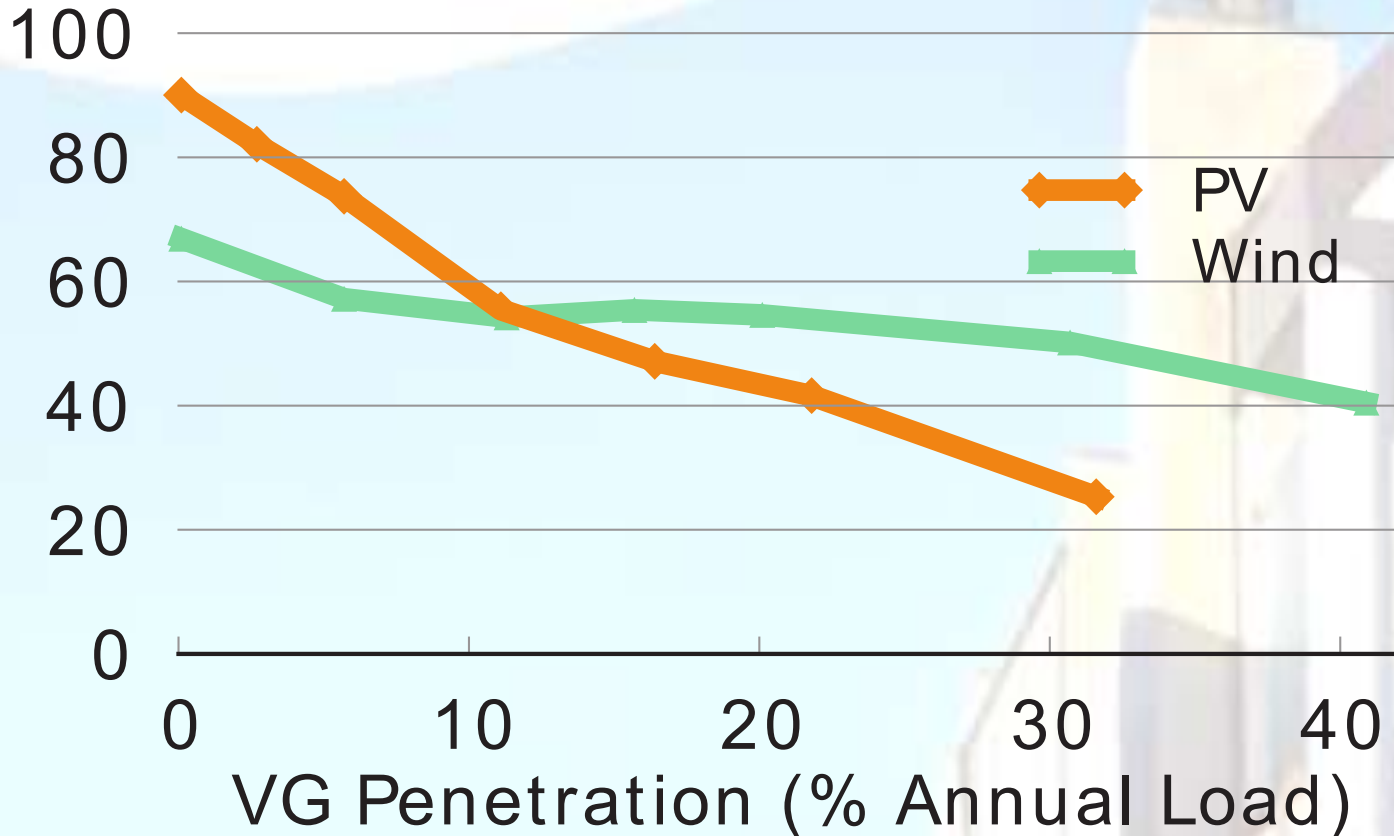

Mills and Wiser (2012)

# PV Displaces the Cleanest Power

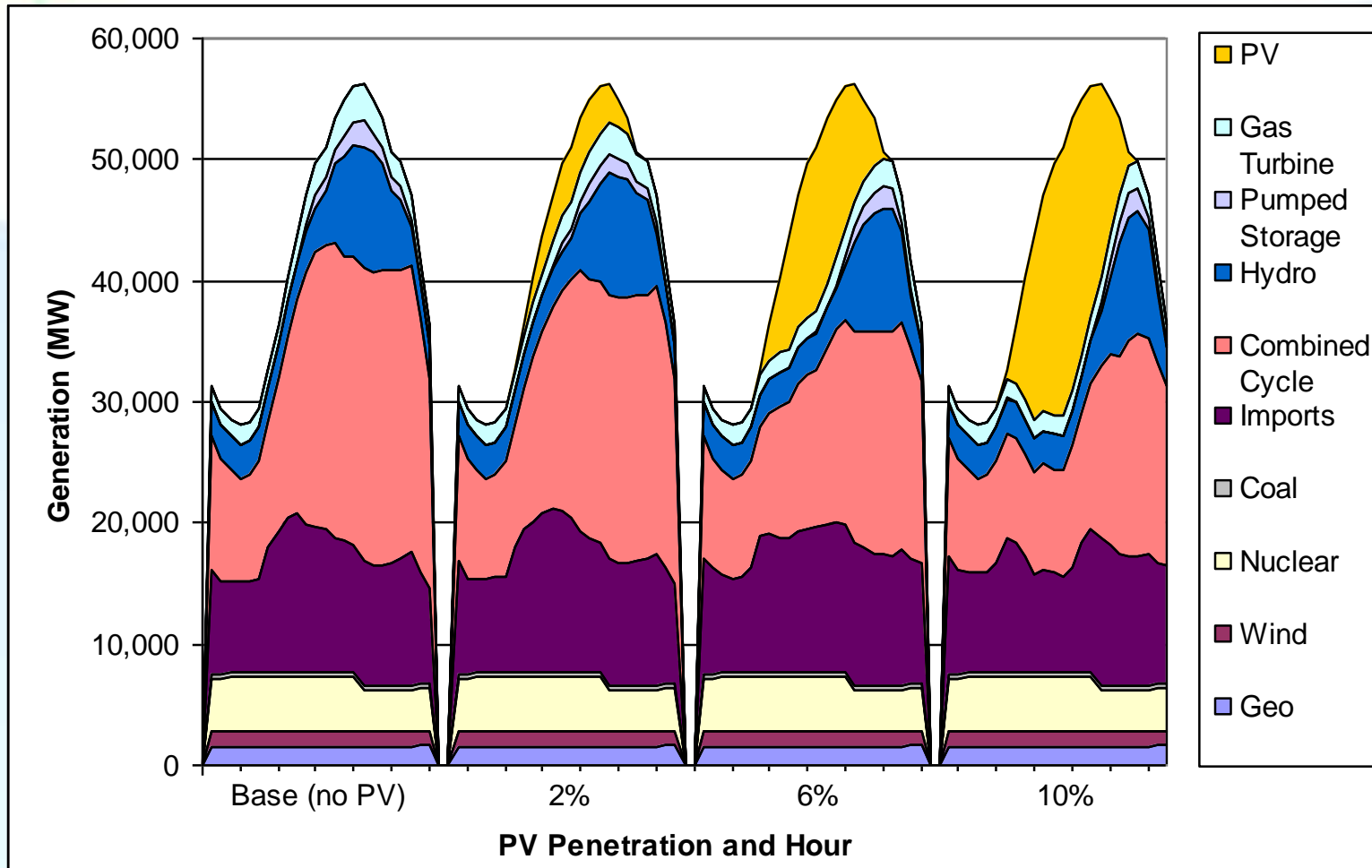

**Simulated Dispatch in California for a Summer Day  
with PV Penetration from 0-10%**

Denholm et al. 2008

# Curtailed PV - Extreme Case

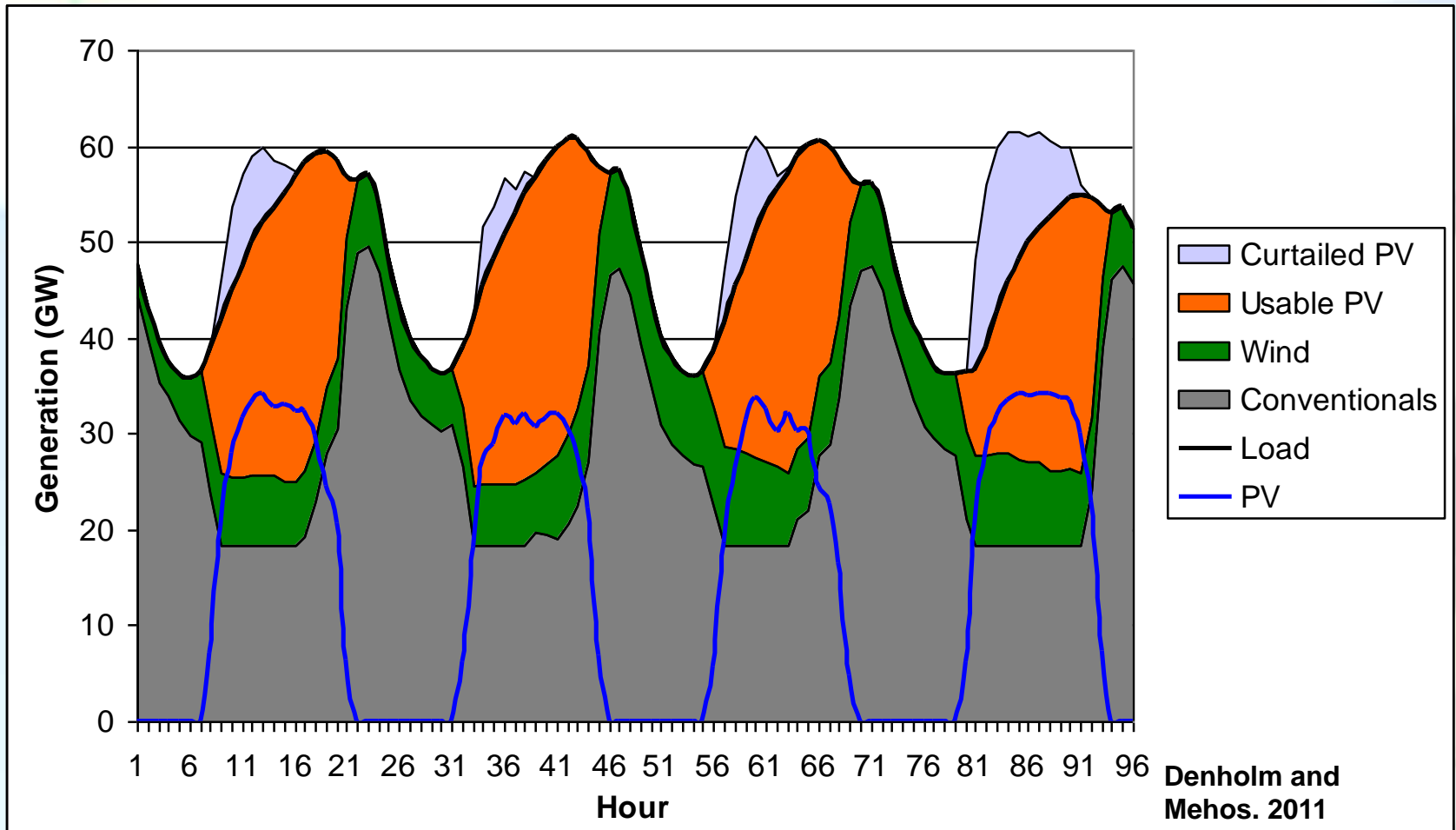

## 20% Contribution from PV



# Curtailment is Flexibility Dependent

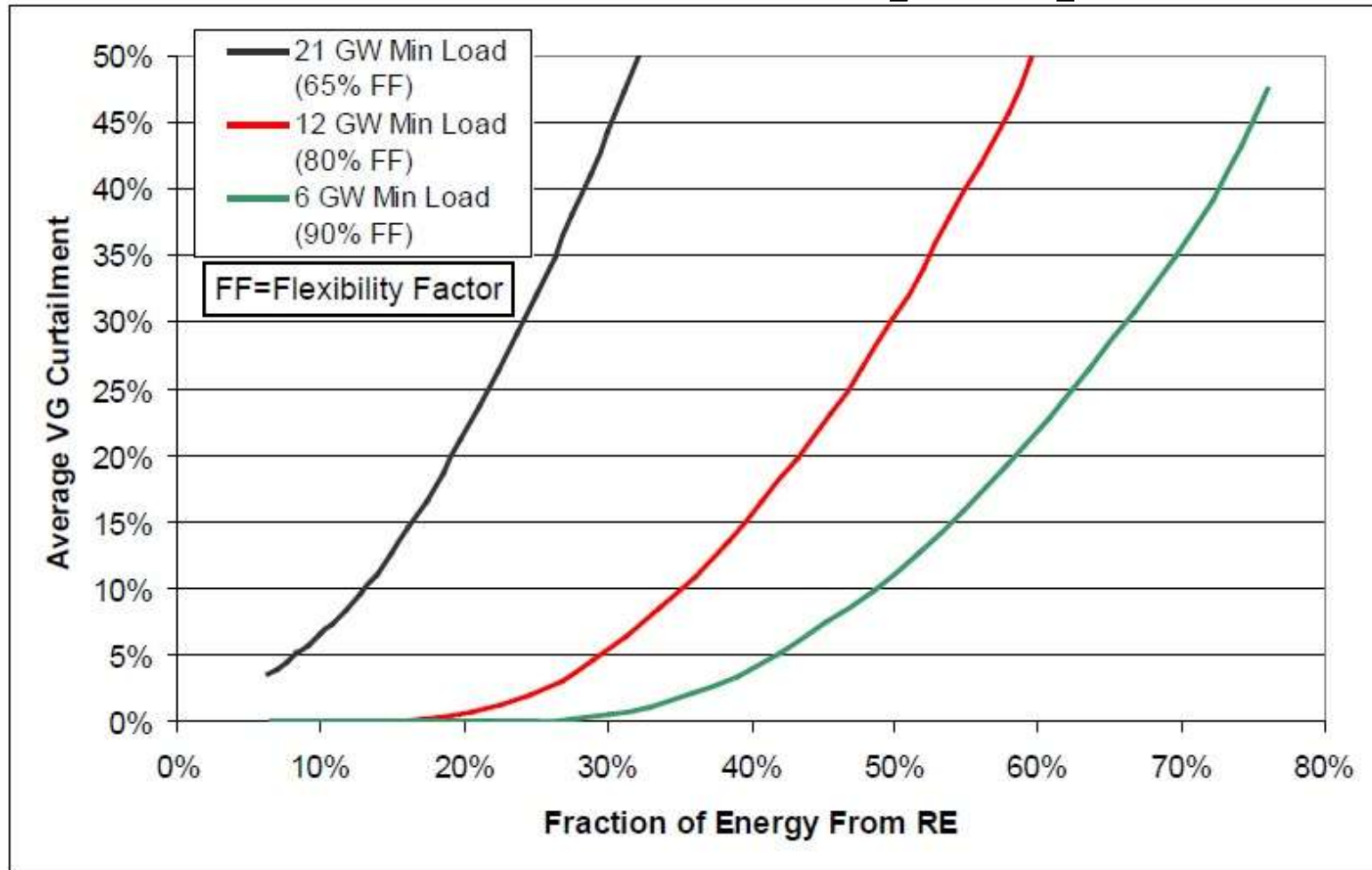
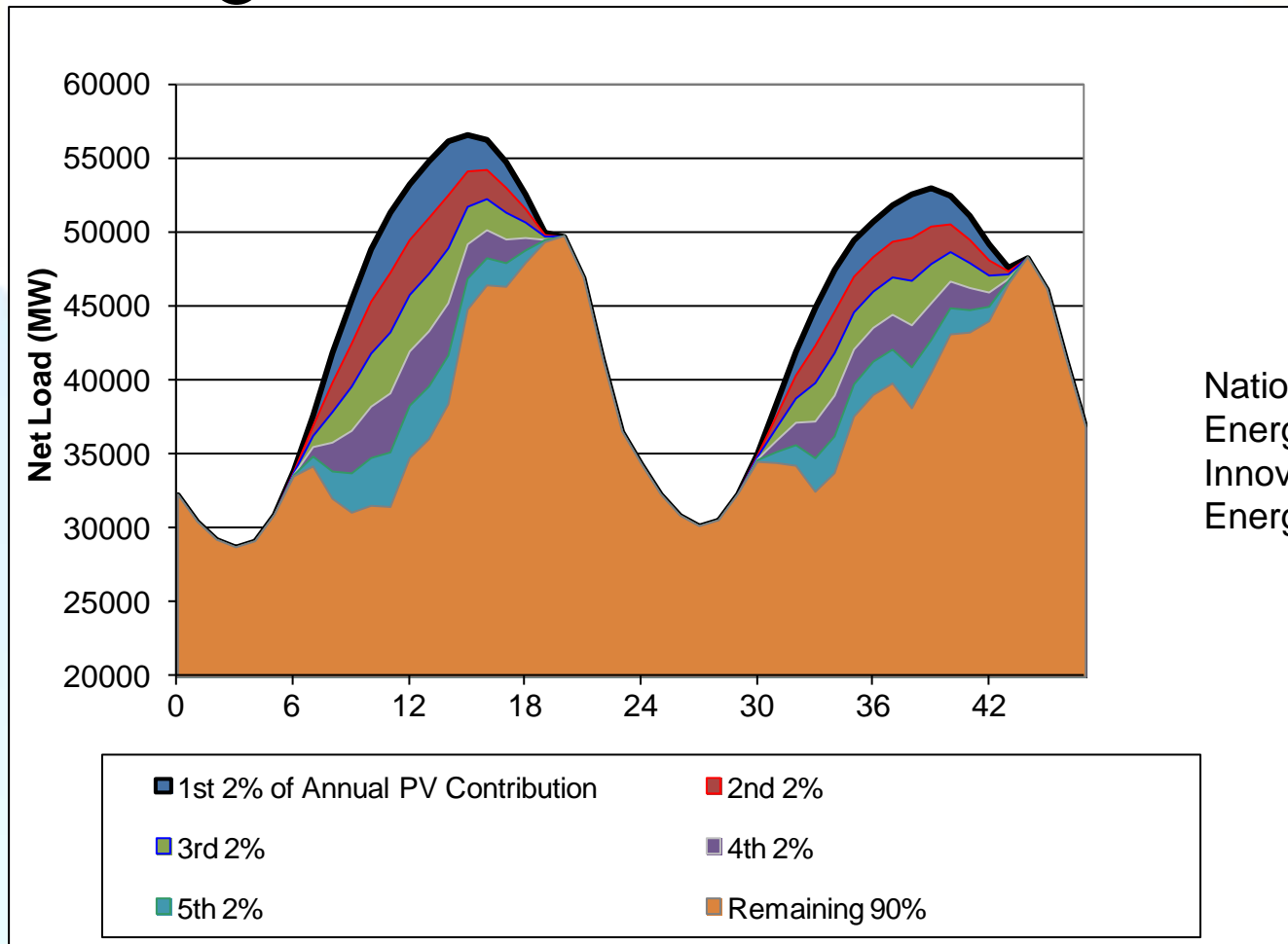

Figure 4.7. Average curtailment rate as a function of VG penetration for different flexibilities in ERCOT

# Increasing PV Penetration Shifts Peak



National Renewable  
Energy Laboratory  
Innovation for Our  
Energy Future

Denholm and  
Mehos. 2011

**Summer net load in California with scenarios of 2% incremental PV penetration**

# Even Predictable PV Loss Wastes Energy

Net Load and Flexible Capacity Needs –  
SDG&E



## System Low Days

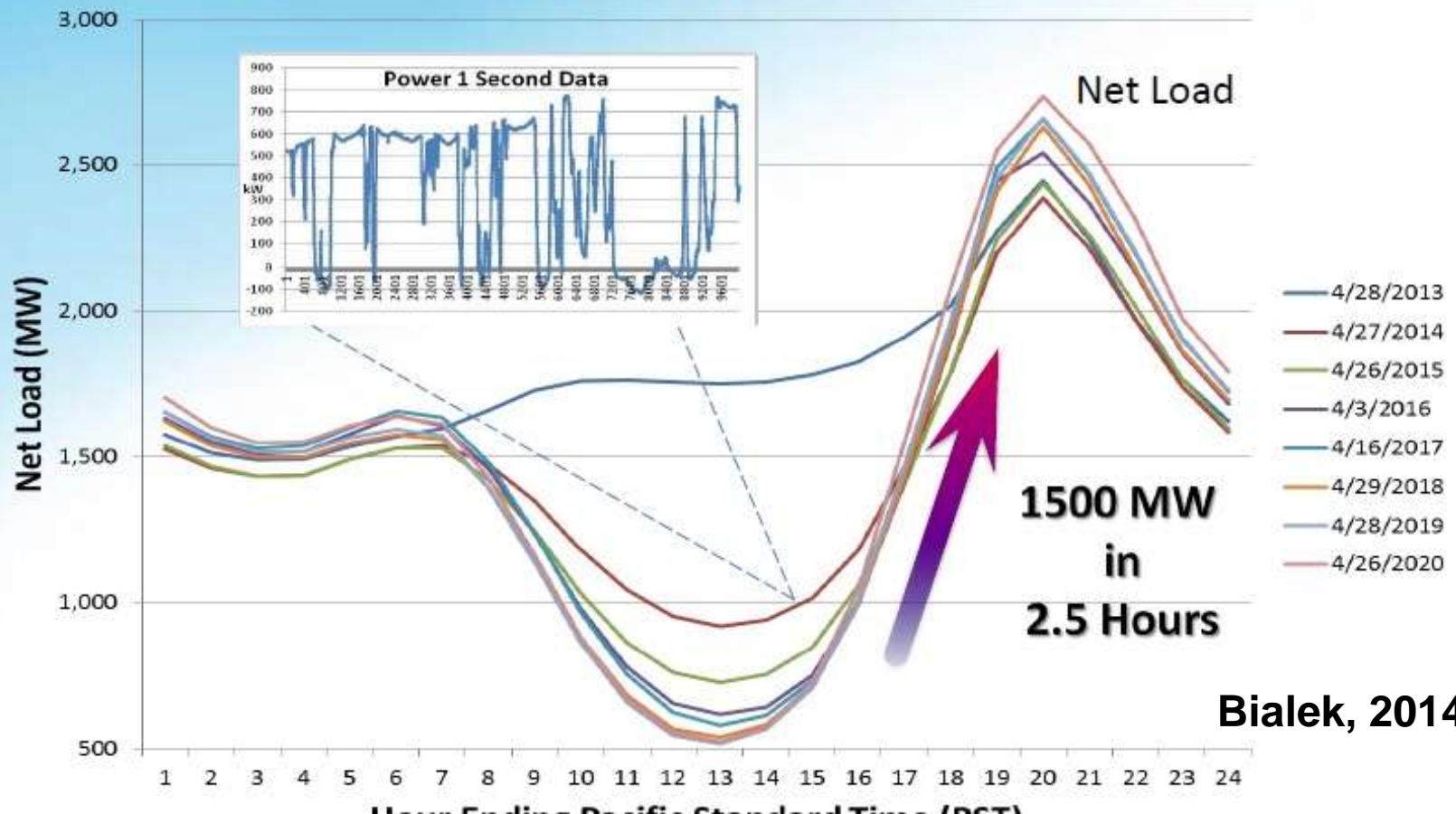

Bialek, 2014

# Low-cost Storage Can Mitigate the

Marginal Economic Value of PV

(\$/MWh)

100

## Decline in the Value of PV

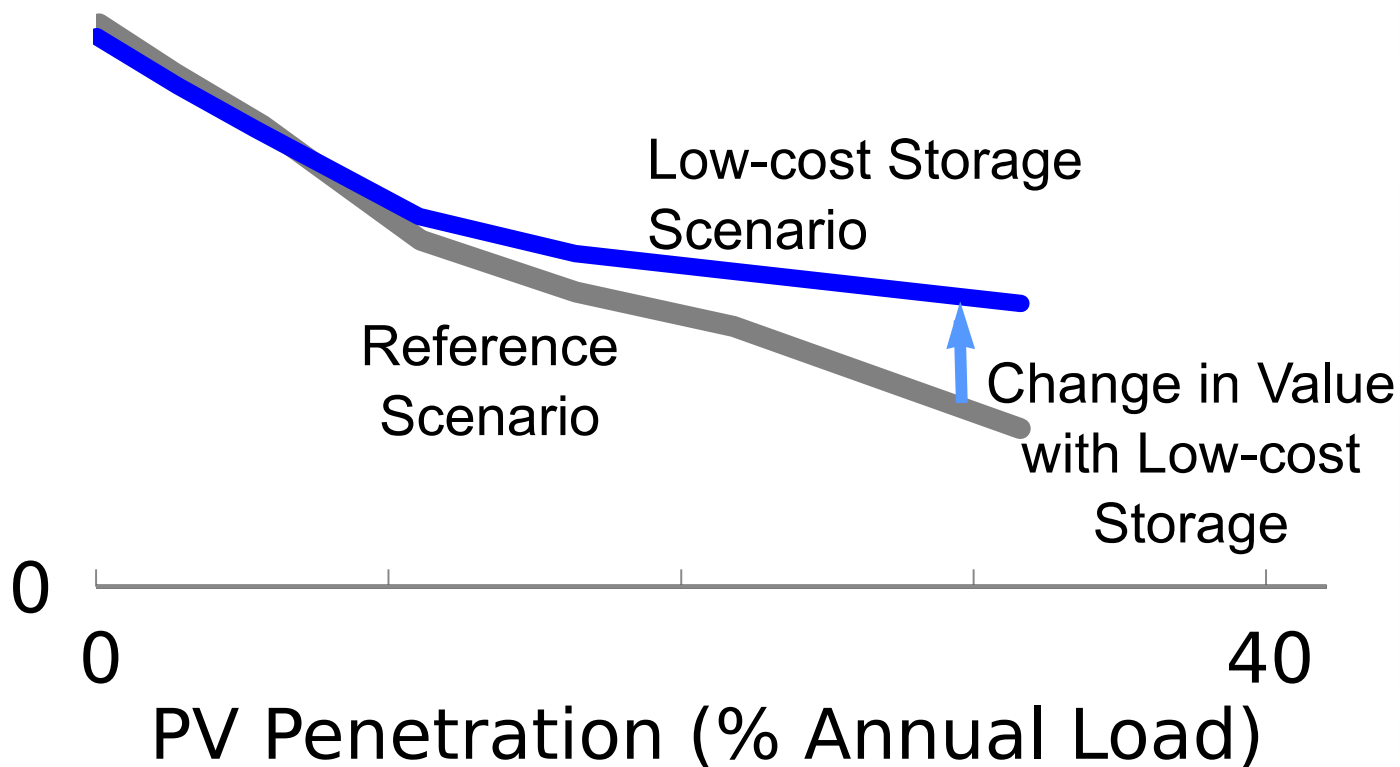

Mills and Wiser (forthcoming)

# Grid-Controlled Storage Better for PV

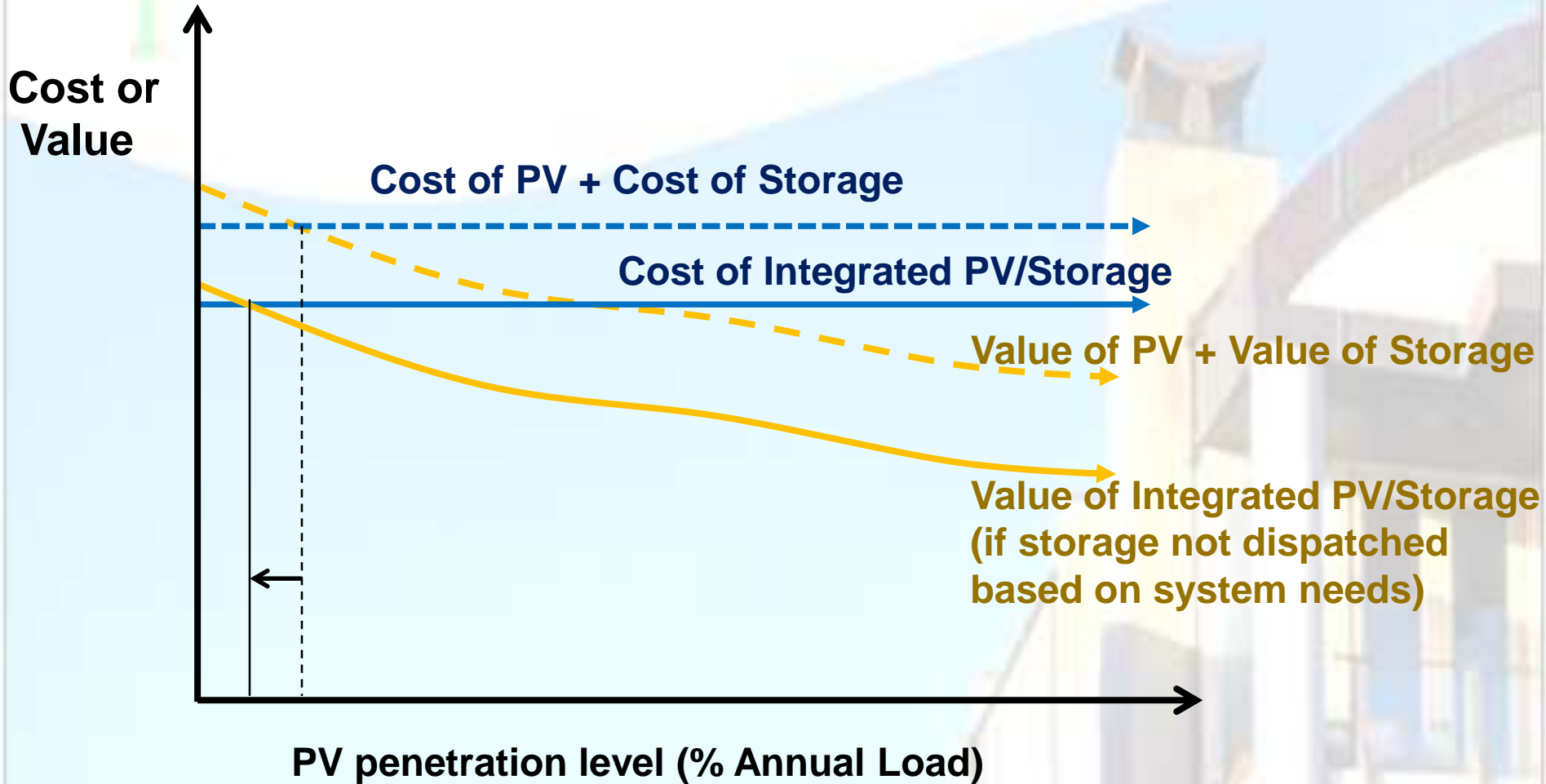

Mills



# PV Curtailment is Penetration Dependent

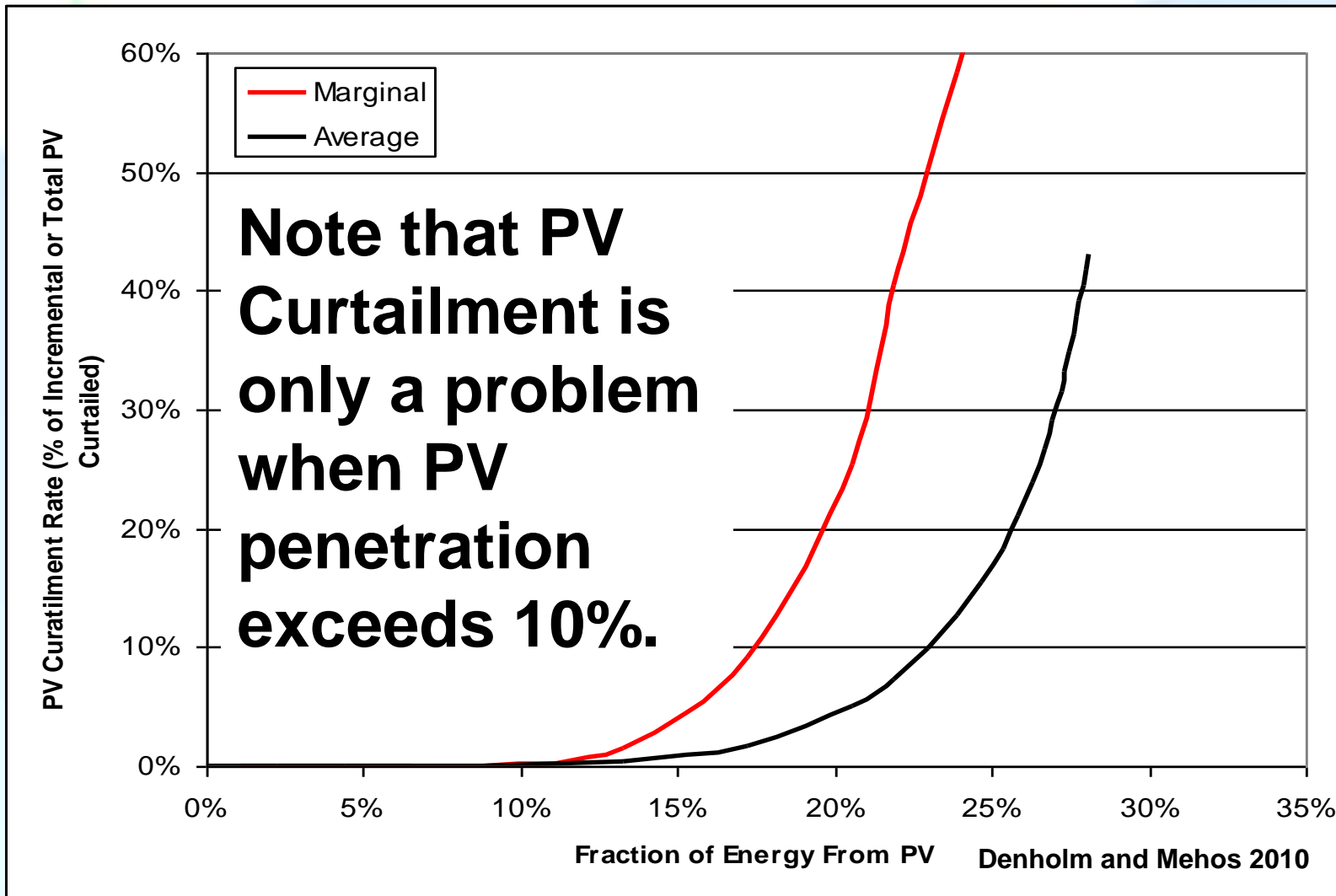

# **What does all of this mean?**

To get a renewable energy future, we need very much more Solar Energy and to get that we may need a lot of batteries installed on the grid, and they should be controlled by the utility grid operator as opposed to the consumer.

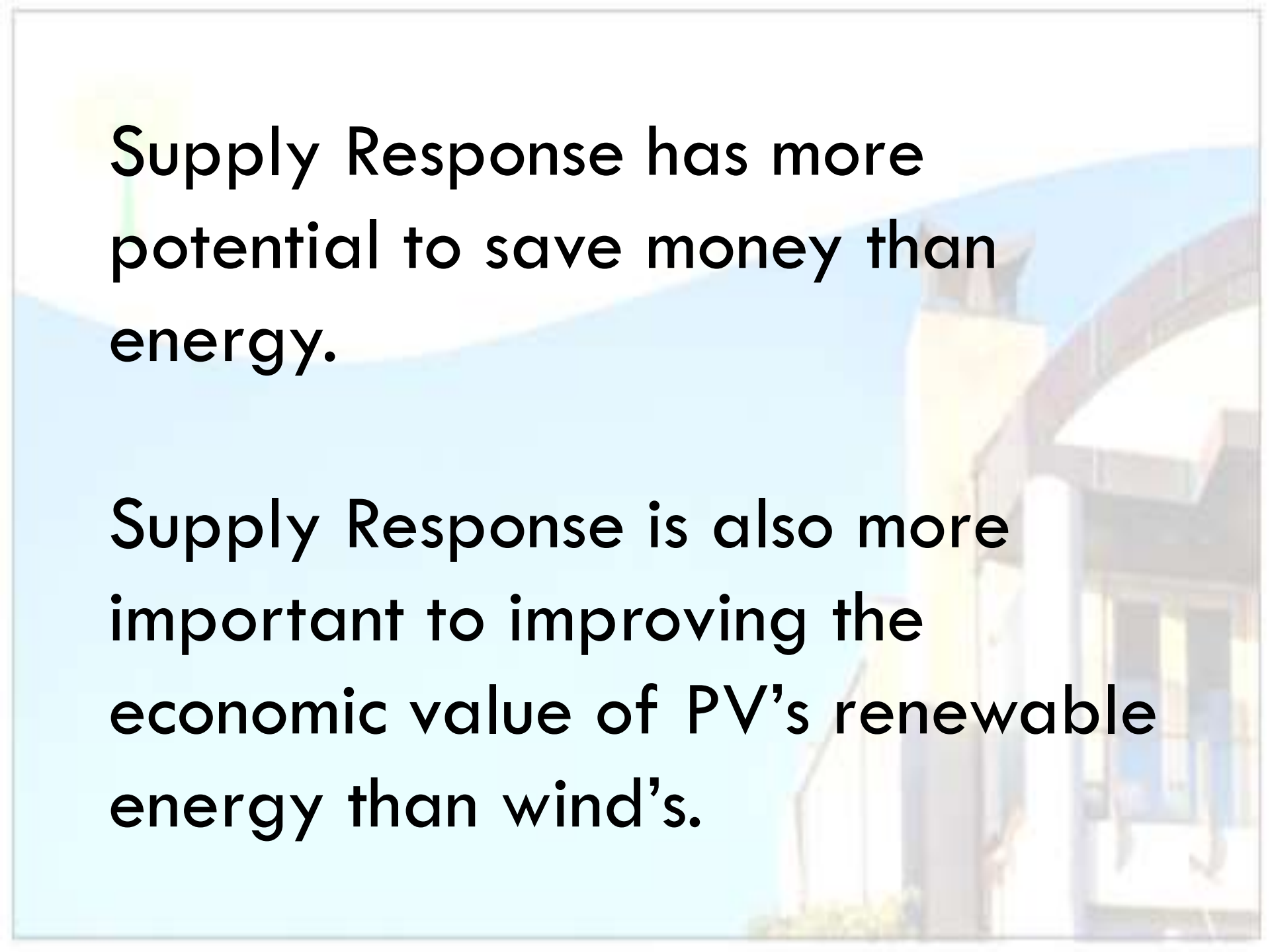

Supply Response has more potential to save money than energy.

Supply Response is also more important to improving the economic value of PV's renewable energy than wind's.

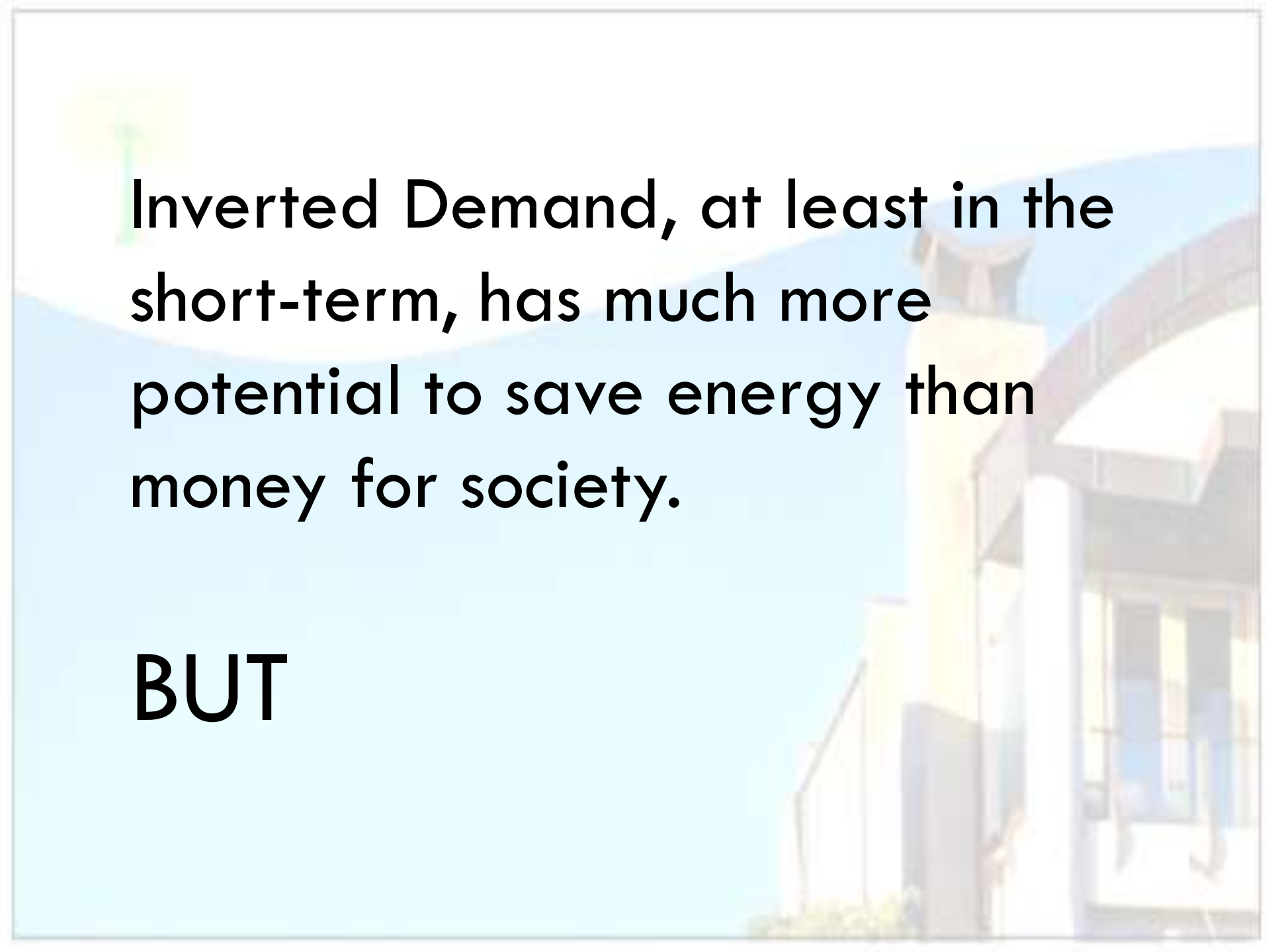

**Inverted Demand, at least in the short-term, has much more potential to save energy than money for society.**

**BUT**



The potential societal benefit, measured in externalized environmental costs, can be extremely high because **Inverted Demand** may offer the substantial bonus of reducing global warming and, if so, could help save many tens of trillions of dollars.



# **Massive investment is needed to retain Reliability within Electricity 1.0.**

“The grid is aging and becoming more unreliable. Instead of massive investment in the entire grid for current reliability, we need targeted investment (at a much lower cost) to clear bottlenecks and provide sufficient reliability to allow creation of the new inverted demand system.”

-- Tommy Milliner

- Electric utilities are very concerned about the mandate to absorb non-dispatchable electricity from PV because, for the reasons stated above, PV shifts more and more costs onto the utility.
- IDCC ameliorates these problems substantially, but teamed up with Electricity 3.0, they provide a light at the end of the tunnel for a future where high PV penetration can be a win-win-win.

# **IDCC is Readily Adaptable to the Developing world.**

This is the case since installation only requires about \$5000 of hardware and very minimal electrical contractor skills.

The lack of significant transmission infrastructure is a much bigger problem for Electricity 1.0 than Electricity 3.0.

# REGIONAL SHARE OF CO<sub>2</sub> EMISSIONS

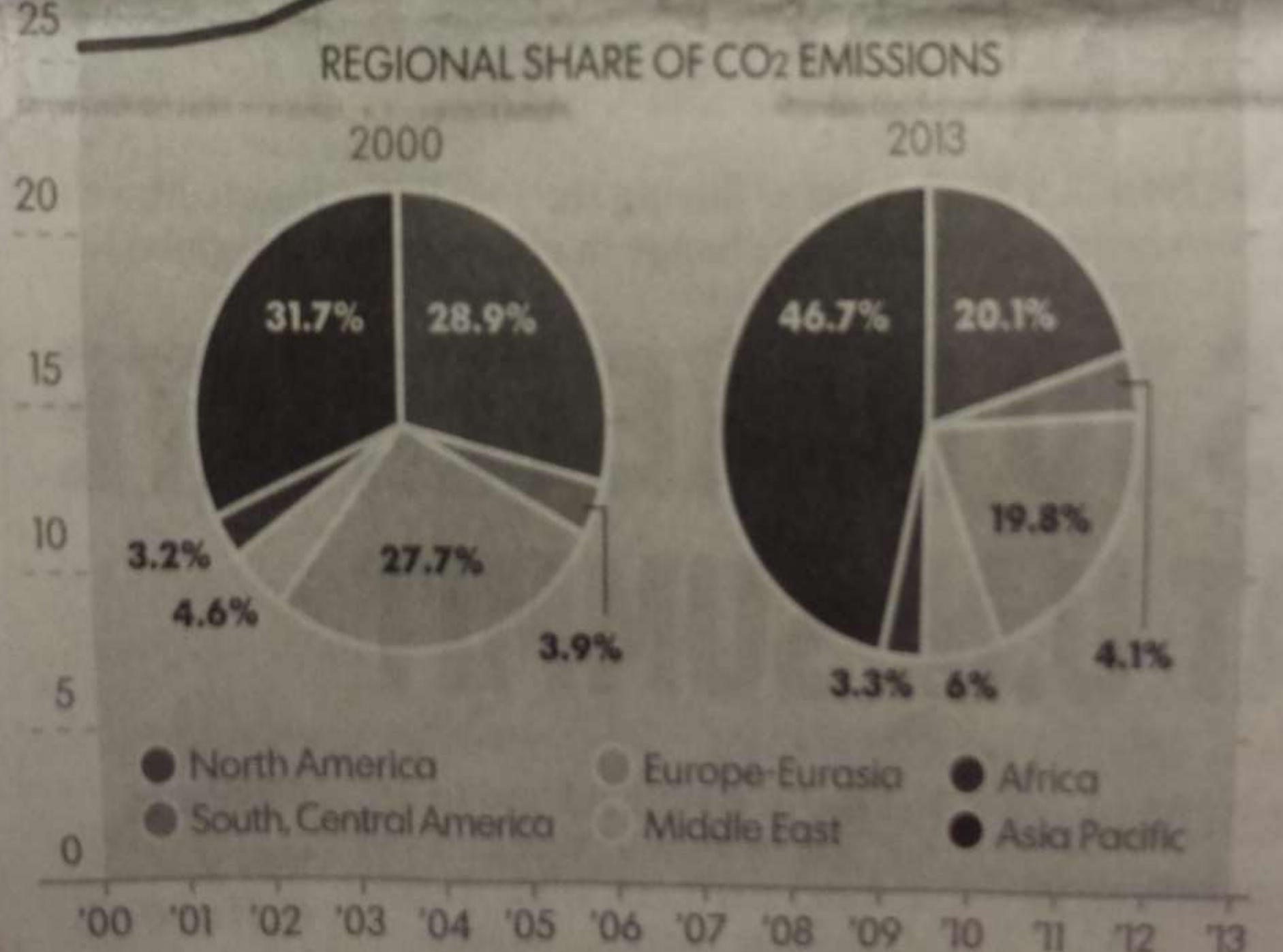

# **In Part 3, you learned:**

**IDCC, with or without Electricity 3.0, improves reliability, reduces CO<sub>2</sub> production, enhances renewable energy penetration, lowers the cost of electricity and is easily exported to developed and developing world.**



Q 2 W S T O N ?



# Part 4

**IDCC pushes building science to help buildings coast from 5 AM to 1 AM.**



I really mean ***5 AM to 1 AM.***

This is 20 hour coast!



# **Change Tracks!    Change your goal from**

*Energy efficiency -- using fewer kWh*

*to*

*Energy conservation -- generating less CO<sub>2</sub>.*



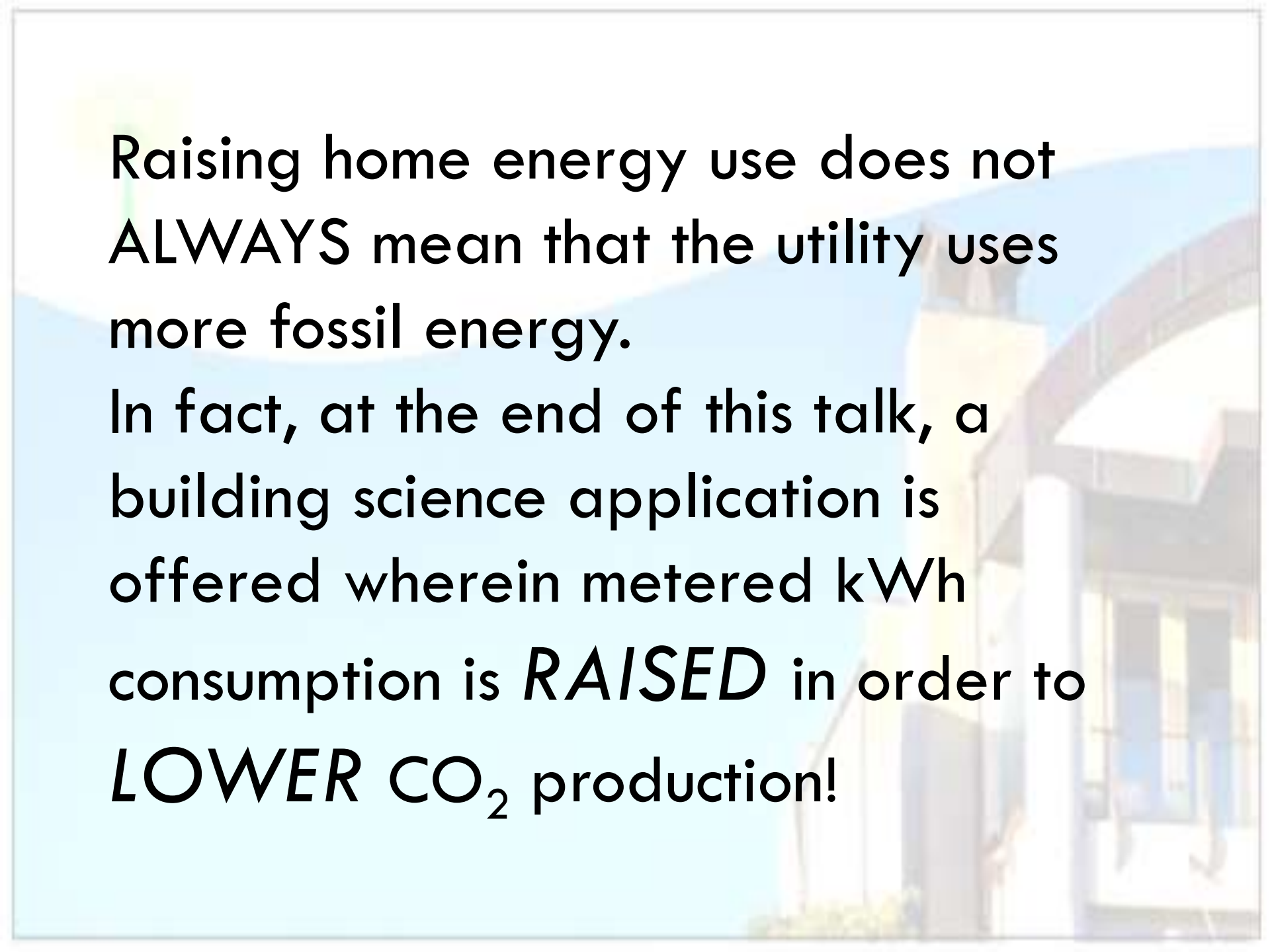

Raising home energy use does not ALWAYS mean that the utility uses more fossil energy.

In fact, at the end of this talk, a building science application is offered wherein metered kWh consumption is *RAISED* in order to *LOWER* CO<sub>2</sub> production!



As energy professionals we normally think that reduction in energy used by the utility is ***directly proportional*** to decreased metered consumption. But,

*Is the ratio of fossil-fuel consumption by the utility to energy metered at the home essentially constant or constant on average?*

The ANSWER IS: *Neither!*

- Even when all electricity comes from burning fossil fuels, this ratio is very *time-of-day & day-of-year* dependent.
- Even if this ratio were *essentially constant when averaged over a year*, the *averaged over a year* ratio is also becoming increasingly time-dependent.
- This is caused by the rapid incorporation of non-dispatchable renewable energy onto the grid: PV by 74%/year over the last five years!

# ~4.2 GW PV in 2013

FIGURE: U.S. PV Installations by Market Segment, Q1 2010-Q3 2013

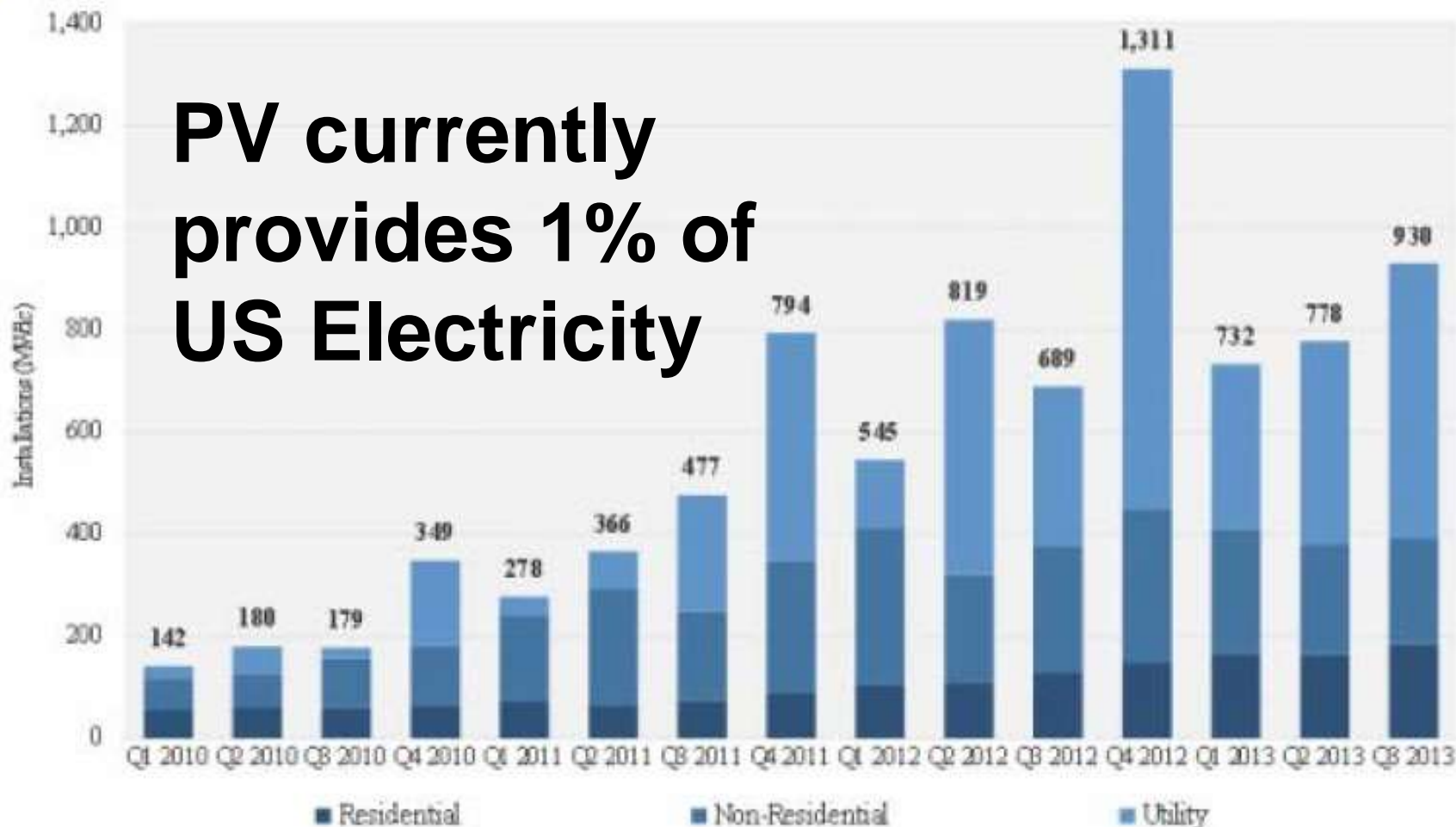

Source: U.S. Solar Market Insight Q3 2013 – GTM Research/SEIA

# US Residential Energy Use *BY & FOR*\*

**47%** Conversion, Transmission & Distribution

**24%** Space Heating

**8.7%** Water Heating

**5%** Sensible Space Cooling

**2%** Latent (moisture) Space Cooling

**4.5%** Lighting

**3.5%** Electronics i.e., TV

**3%** Refrigeration

**2.8%** Cooking

**2.5%** Clothes Dryers

**1%** Computers

**3%** Phantom Loads = Standby Waste

**2.4%** Other

\* % of Primary Energy

# US Residential Energy Use *BY & FOR*\*

Computers 1%

Clothes Dryers 2%

Refrigeration 3%

Cooking 3%

TV etc. 3%

Lighting 4%

Latent Cooling 2%

Sensible Cooling 5%

Water Heating 9%

Space Heating 24%

Conversion,  
Transmission  
& Distribution  
47%

\* % of Primary Energy

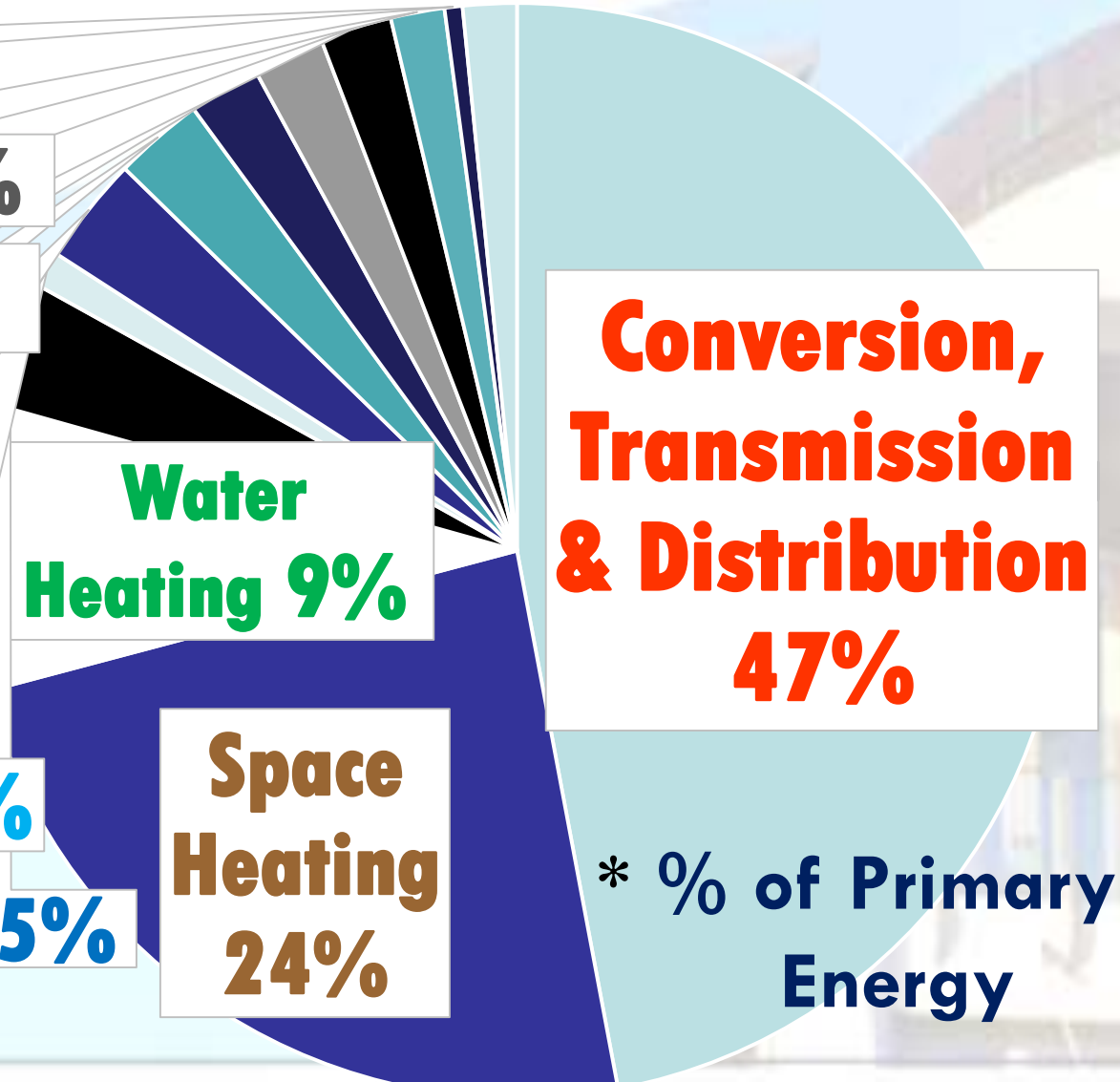





Building scientists focus upon using *energy efficiency to reduce kWh use.*

Because much of the energy used for a U.S. home *never gets to the home*, our standard approach—*using energy efficiency to reduce kWh consumption*—is not sufficiently robust.

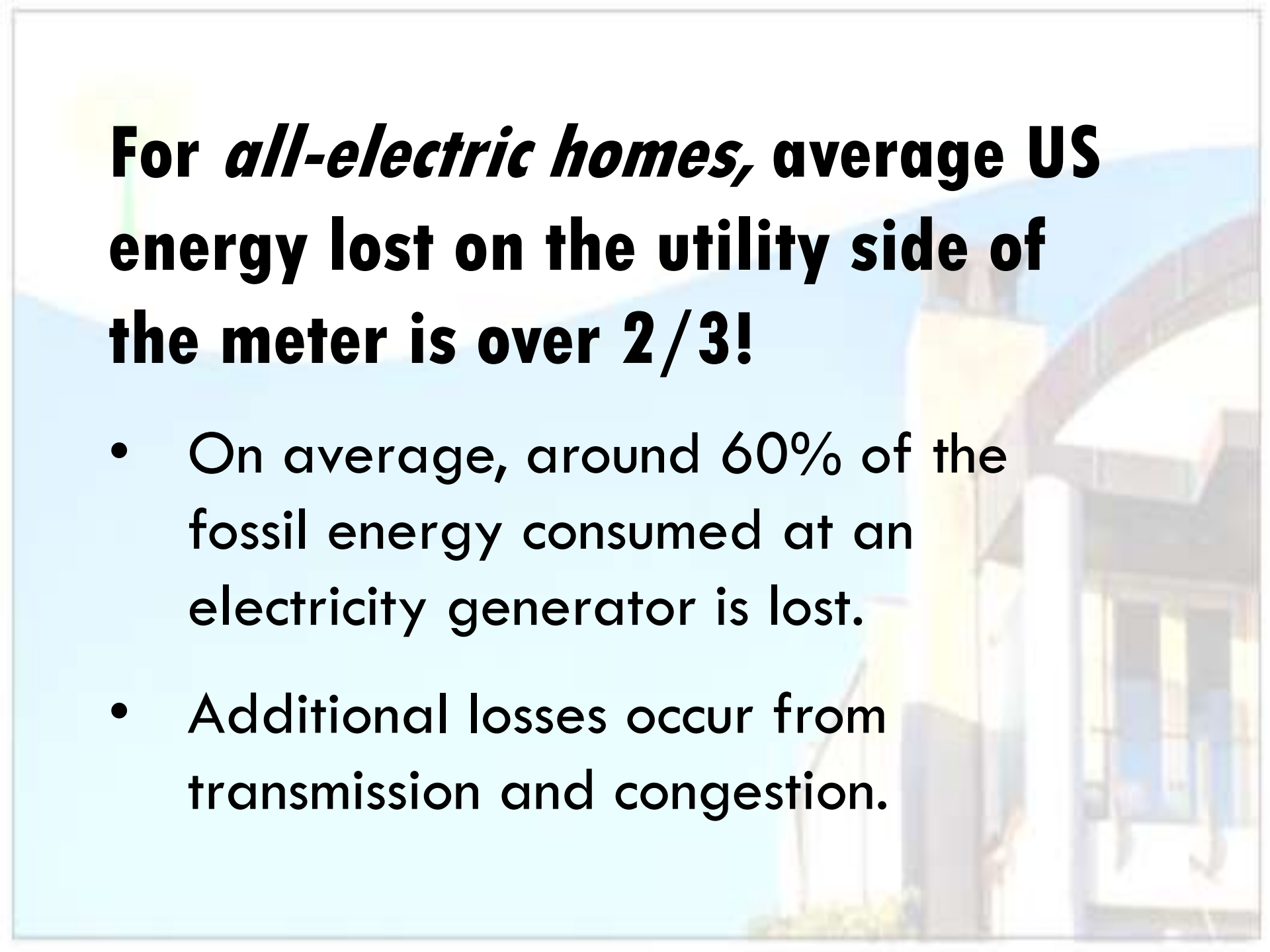

**For *all-electric homes*, average US energy lost on the utility side of the meter is over 2/3!**

- On average, around 60% of the fossil energy consumed at an electricity generator is lost.
- Additional losses occur from transmission and congestion.

## Physical Reality of Transmission Line Losses



108 MW Generated



100 MW Received

- Transmission lines act as a resistance to the flow of energy
  - To receive a specific quantity of energy at one end of a line, more than the expected quantity must be injected at the other end
  - Power Losses expressed by:

$$P_{loss} = I^2 R = \frac{P^2 R}{V^2}$$

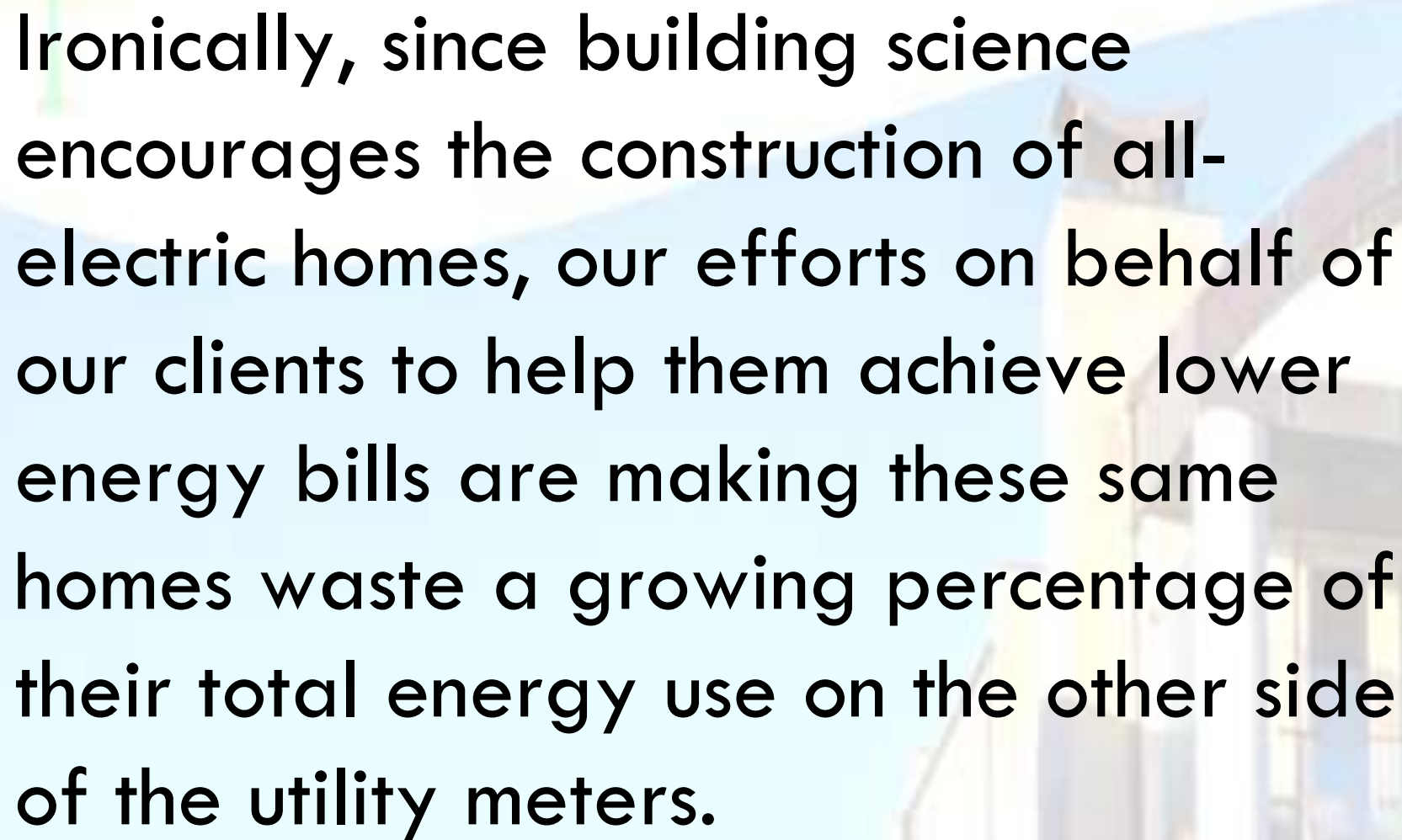

**Ironically, since building science encourages the construction of all-electric homes, our efforts on behalf of our clients to help them achieve lower energy bills are making these same homes waste a growing percentage of their total energy use on the other side of the utility meters.**

# What are the **MEANS** of Energy Conservation?

Here is a tool of one of them:

I call its means:

***Energy Conservation by Control.***

3 slides following is a list of 20 means of energy conservation that is by no means inclusive of everything that can be conceived.





# **20 MEANS of ENERGY CONSERVATION** *for buildings*

The first four, Efficiency, Control, Environmental Coupling and Timing are the biggies.

Among them, *Control*, is purposely ignored by RESNET, and the fourth, *Timing*, is grossly under used by both the building science and utility industries.

# Energy Conservation by Timing

A primary purpose of this talk is to develop and promote deeper exploitation of this way to avoid CO<sub>2</sub> production.

***Timing is defined as any method that conserves because the energy service is provided after the energy is stored, collected or produced.***

E.g., run capacitor of an electric motor, thermal mass wall and ground-coupled heat pumps... *and* IDCC!



# **20 Means of Energy Conservation**

1. Efficiency (use less energy to do the same job)
2. Control (do the same job but at varying times)
3. Environmental Coupling (utilize energy flows from outside)
4. Timing (use energy later than it was generated, collected or stored)



# Tools of Control







# Environmental Coupling



**SOLAR DRYER**



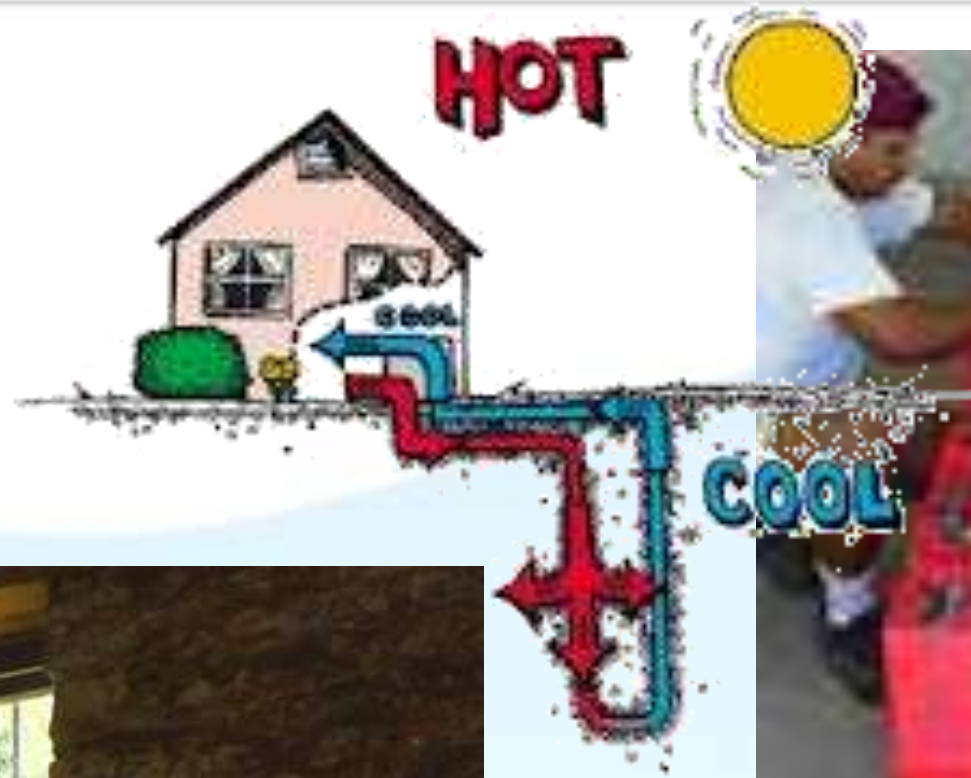

**Timing**

## **20 Means of Energy Conservation**

5. Lower gradients (use smaller temperature difference)
6. Revise goals (alter goal of energy end use)
7. Ancillary effects (fully credit positive ancillary effects of an energy flow)
8. Anti-Ancillary effects (fully credit negative ancillary effects of an energy flow)



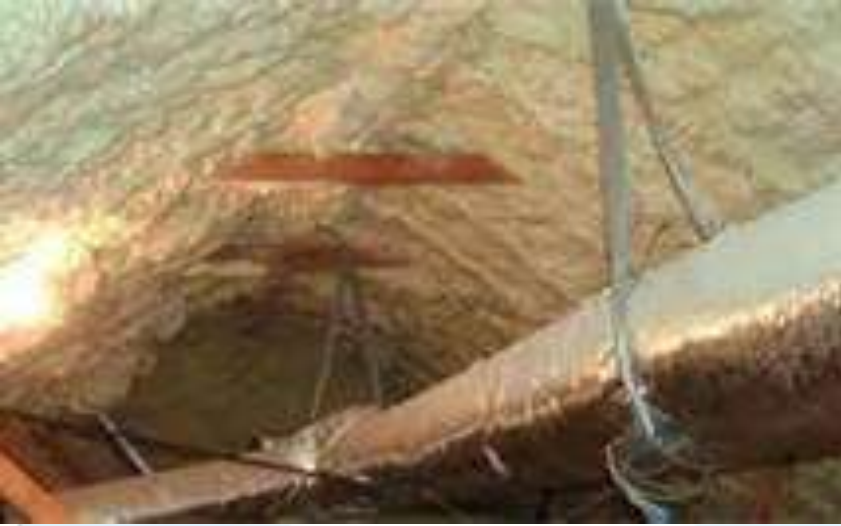

# Ancillary Effects

Traditional type hot water circulating system.

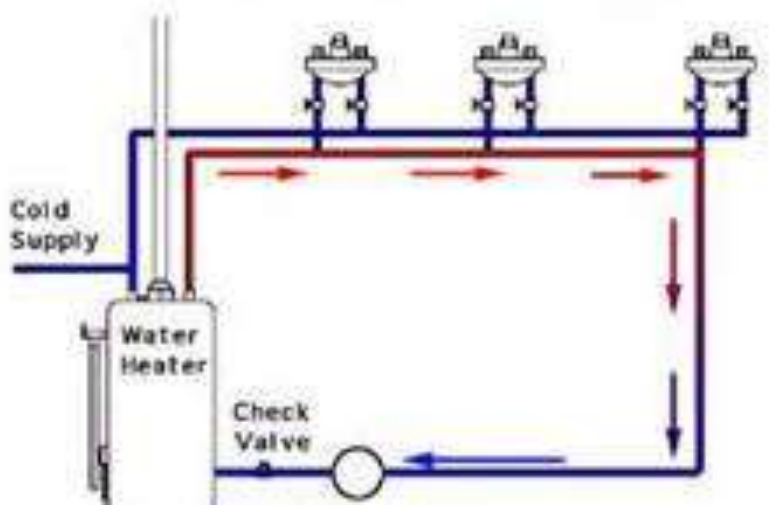

# **20 Means of Energy Conservation**

9. Minimize phantom or standby loads
10. Flexibility (vary ratio of output end uses)
11. Decoupling (disassociate End Uses)
12. Switch to 2nd generation/higher quality End Uses



# **20 Means of Energy Conservation**

13. Proximity (deliver energy closer to need)
14. Long cycling (utilize long on/off cycles instead of short cycles)
15. Improve Operation and Maintenance. (e.g. dirty filters waste energy)
16. Use Demand Response instead of Spinning Reserve to handle challenging drops in supply

## **20 Means of Energy Conservation**

17. Minimize generation losses: i.e., converting primary energy into electricity
18. Minimize transmission and distribution losses and congestion
19. Minimize the fossil energy used to produce fossil fuels
20. Renewable Energy (actively collect natural energy flows and convert to electricity)

# **What can the building scientist do to facilitate IDCC?**

Clearly, all of the Passive Solar strategies that you have learned are relevant here. In my opinion, the archetypical example is the wall of the adobe home. However, that is a very climate- and geology-specific solution. Thermal mass easily charges and discharges diurnally.

# **Water Heating and Space Cooling**

Are the two biggest energy hogs of a home.

We will focus on the water heating first and then explain how it can grossly decrease HVAC use.

These are often overlooked opportunities to shift electricity demand from the grid to the early morning hours.

# **For Water Heating to Aid IDCC, We Need**

**Timed control:**

**Heat water between 1 and 5 AM**

**Larger tank**

**Better insulation**

**Higher temperature**

**More kWh used.**

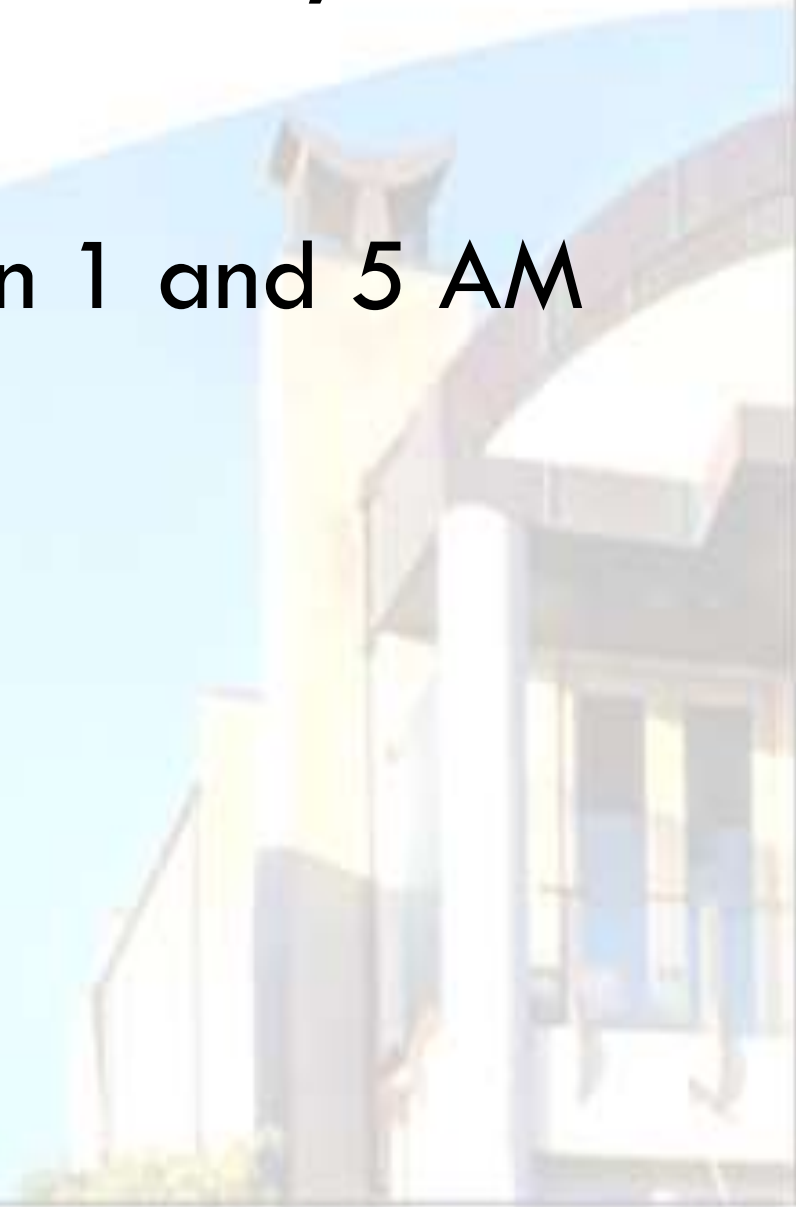



- ***This process is just the opposite of energy efficiency: from the point of view of kWh consumed, we need more energy input to get the same energy service output.***
- ***The energy saved cannot be perceived by the conventional meter.***
- ***In this case, energy conservation by timing is actually counter to energy efficiency.***
- ***But from the point of view of the utility's energy consumption, substantial fossil fuel conservation happens.***

A typical, domestic heat pump water heater runs like a window AC with a 1/2 ton compressor. It takes about 1.5 hours to reheat 25 gallons of water to 120°F from 80°F input.

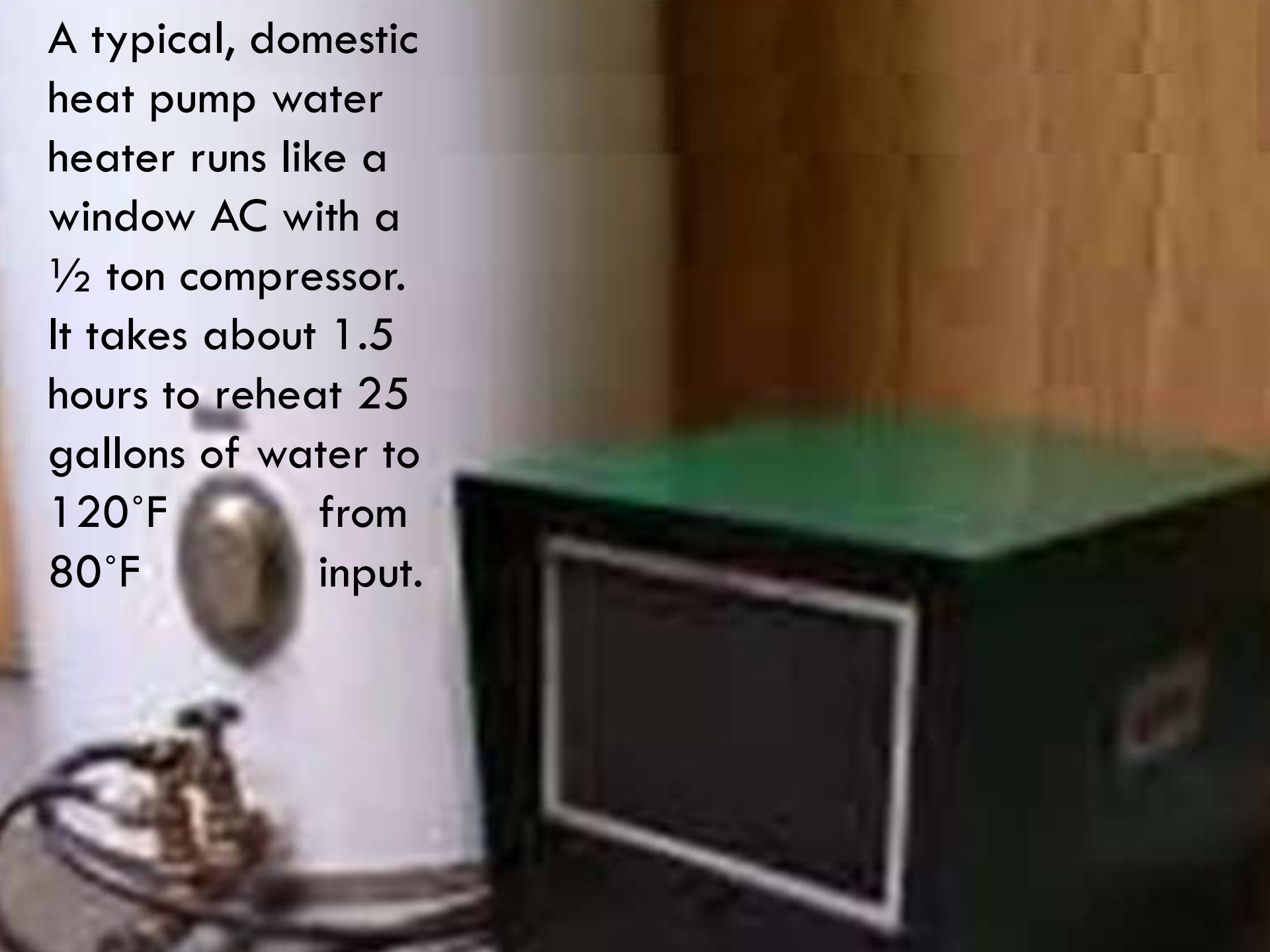

# Heat Pump Water Heaters can greatly facilitate Inverted Demand.

- With a heat-pump water heater, the energy needed to heat the tank can be less than  $1/3$  as much as needed to operate a conventional electric water heater.
- Similarly, the demand for power would be much lower.
- This means that both the battery size and the inverter size can be made much smaller: the battery bank by 60%, the inverter by 80%.

**Can we  
make  
*Hygric  
Mass*  
work  
for  
IDCC?**



# Heat Pump Water Heaters may save more cooling energy than water heating energy!

- These can grossly impact HVAC use and do it in a way that inherently inverts demand.
- Consider: *ancillary effects energy-conservation*
- The water heater cools and **dries** the air in the home to heat water.
- Remove  $\frac{1}{4}$  gallon while heating 25 gallons.



# **A Heat Pump Water Heater dries the air.**

1. Heating up a 100 Gal Tank takes a gallon of water from the air
2. The home's air can't hold a gallon of water so much of the drying is imposed upon wood veneers.
3. After water heating stops, these veneers will buffer the wetting of the inside air during the next 18 hours.
4. This greatly lowers the need for cooling.

# **“There are a lot of cheaper storage methods than batteries.**

I would start with electric cars and hybrids, go on to dimmable lighting (15% dimming cannot be perceived) and HPWHs as you suggest, and then go on to AC cycling which works a lot better with VFDs [variable frequency drive motors] than in the old days, and load-shedding appliances. Precooling buildings can also provide cheap storage. There is undoubtedly much more we can do if the tariffs start making it cost-effective...”

-- David Goldstein 8/2014.

# **In part 4, you learned**

IDCC redirects building science to replace *Energy Efficiency*, i.e., lowering *kWh use* with *Energy Conservation*, i.e., *reducing CO<sub>2</sub> production*, and focus upon *timing* to avoid CO<sub>2</sub>, all to develop improved systems to help the building coast from 5 AM to 1 AM.

# **IDCC in Summary**

- 1. IDCC's gets value from both sides of the meter.**
- 2. Coupled to a revolution in grid design, IDCC greatly improves reliability & lowers cost.**
- 3. IDCC enhances PV and WIND penetration and is easily exported to the developing world.**
- 4. IDCC pushes building science to help buildings coast from 5 AM to 1 AM.**

Q Q W S H - O Z S S ?







**Myron Katz, PhD**

**Energy Conservation, Moisture and  
Building Scientist**

**Building Science Innovators, LLC**

**302 Walnut St**

**New Orleans, La 70118**

**[Myron.Katz@EnergyRater.com](mailto:Myron.Katz@EnergyRater.com)**

# ACKNOWLEDGEMENTS

I have not taken the proper time to thank the many who have taken time to make this talk as good as it has become. Here are most of their names. Hopefully, I have not missed any and have put them in the proper order.

Tommy Milliner, Michael Holtz, Steven Fenrick, Norman Witriol, David Goldstein, Russ Derickson, Richard Troy, Gary Esolen, Judy Roth, Dan Weiner, Z Smith, Sharon Katz, David Whittle, Elana Stanger and her husband Iden, Marley Porter, Robert Andrews, and others.

# What is Frequency Regulation?

Electricity demand varies constantly throughout any given day. Frequency regulation is **the use of special resources to provide a small injection or removal of power into the grid to ensure the grid operates at a desired frequency of 60 Hz.** This helps to smooth volatility by increasing or decreasing electricity usage at various sites throughout the grid. These adjustments match load with generation so the grid's desired frequency is maintained.

# Active Frequency Regulation

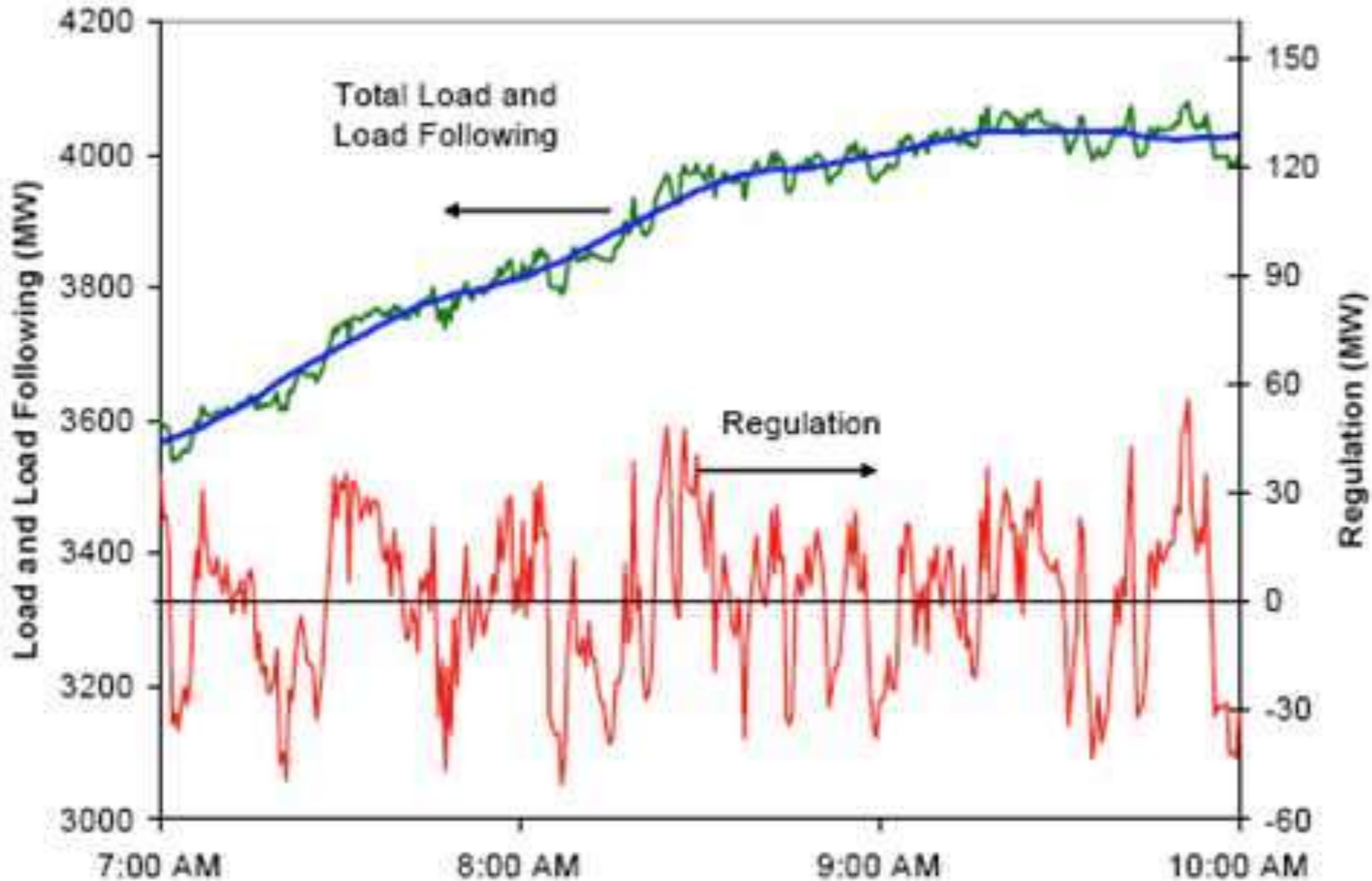

# Internal Rate of Return (IRR)

- IRR is defined to be the fixed, compound interest rate a bank must pay you so that a particular series of deposits and withdrawals into a single account results in a zero balance.
- IRR is easily calculated by setting  
Present Value = 0  
and solving for  $r$ .
- IRR is useful because it lets you compare worthy investments against each other.



# IDCC is as Economical as PV

Using 25 year simulations, I found IDCC's IRR to be about the same as Photovoltaics' over a range of assumptions.

I found assumptions in three categories: those affecting

- both IDCC and PV
- IDCC only,
- PV only.

I choose two sets of assumptions which allowed me to generate results on the edges of the ranges of results.

- Biased For PV, and
- Biased Against PV.

# IDCC is as Economical as PV

Using 25 year simulations, I found IDCC's IRR to be about the same as Photovoltaics' over a range of assumptions.

Assumptions affecting both IDCC and PV were

- Retail Rate Inflation %/yr 4.5%
- Solar Tax Credit (%) 0, 30%, 80%
- Replace Inverter every 15 years.

# IDCC is as Economical as PV

Using 25 year simulations, I found IDCC's IRR to be about the same as Photovoltaics' over a range of assumptions.

Assumptions special to IDCC's investment worthiness were:

- Battery Price (\$/kWh) \$150 & \$400
- Inverter Installed Cost (\$/W) \$1 & \$2
- Size of Utility Bill (\$/m) \$120 & \$210
- Value of Reliability \$/m \$ 50 & \$ 80
- Utility Discount (%) 25% & 50%
- Payment for Regulation \$/m \$5
- Replace Batteries every 5 years.

# Internal Rate of Return Calculator

## Economic Analysis of Myron's IDCC

		4.50%	Electricity Price Inflation		
Inverter & Other Ec	\$2,000	\$1,000	for 4 kW		Replace
	4 kW Inverter and other equipment				Inverter
Batteries	\$3,000	\$150	per kWh		Every 15
	20 kWh AGM Deep Cycle rated for 700 cycles				years
Utility Bills mo avg	\$120	Entergy prices			
	\$210	PG&E prices			Replace
Stream of Value	<b>Utility Discount</b>		<b>Reliability</b>		Batteries
Fenrick	<b>50%</b>		<b>\$50 to \$200/mo</b>		Every 5
					years
Total Investment	\$5,000	Tax Cred	30%		
Jan-12	<b>-\$1,750</b>	<b>IRR</b>	<b>-\$1,750</b>	<b>IRR</b>	
Feb-12	<b>\$105</b>	-95.71%	<b>\$50</b>	-97.96%	

# IDCC is as Economical as PV

Using 25 year simulations, I found IDCC's IRR about the same as Photovoltaics' over a range of assumptions.

Assumptions special to PV's investment worthiness were:

- PV Installed Cost (\$/kW) \$3.5 & \$6.0
- Efficiency of System (%) 80% & 90%
- Average Insolation (Hours/Day) 5
- Retail Price of Electricity (\$/kWh) \$0.12 & \$0.20
- PV Degradation Rate (%/y) 0.25%



# Internal Rate of Return Calculator

**V2G**

**PV system**

3.5

			\$6.0	per installed watt
Inverter &	\$9,000		5,000 W	
Batteries	\$3,600		5 hours/day	
			80% inefficiency effects	
			\$0.20	per kWh
			1460	Annual kWh Production / kW
<b>Frequency Regulation</b>			0.25%	PV degradation
	\$5	per day		
	\$12,600		\$30,000	
Jan-12	<b>-\$8,820</b>	<b>IRR</b>	<b>-\$21,000</b>	<b>IRR</b>
Feb-12	<b>\$150</b>	-99.01%	<b>\$120</b>	-99.43%

# Internal Rate of Return - over 25 Years:

Jan-2012 Investments -- Biased **For** PV

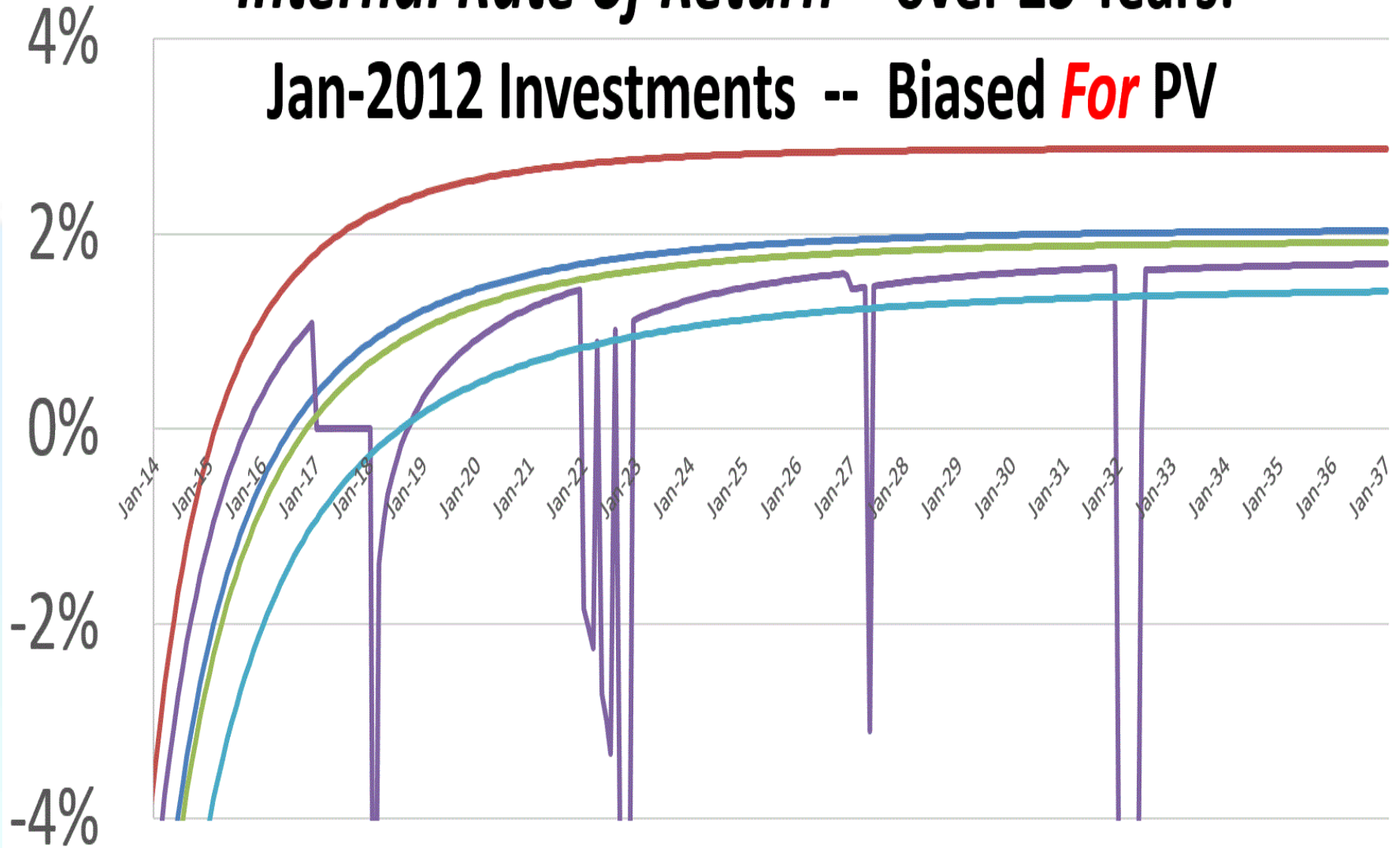

Utility Disc

Reliability

IDCC

V2G - Regulation

PV

# Internal Rate of Return - over 25 Years:

## Jan-2012 Investments -- Biased *Against* PV

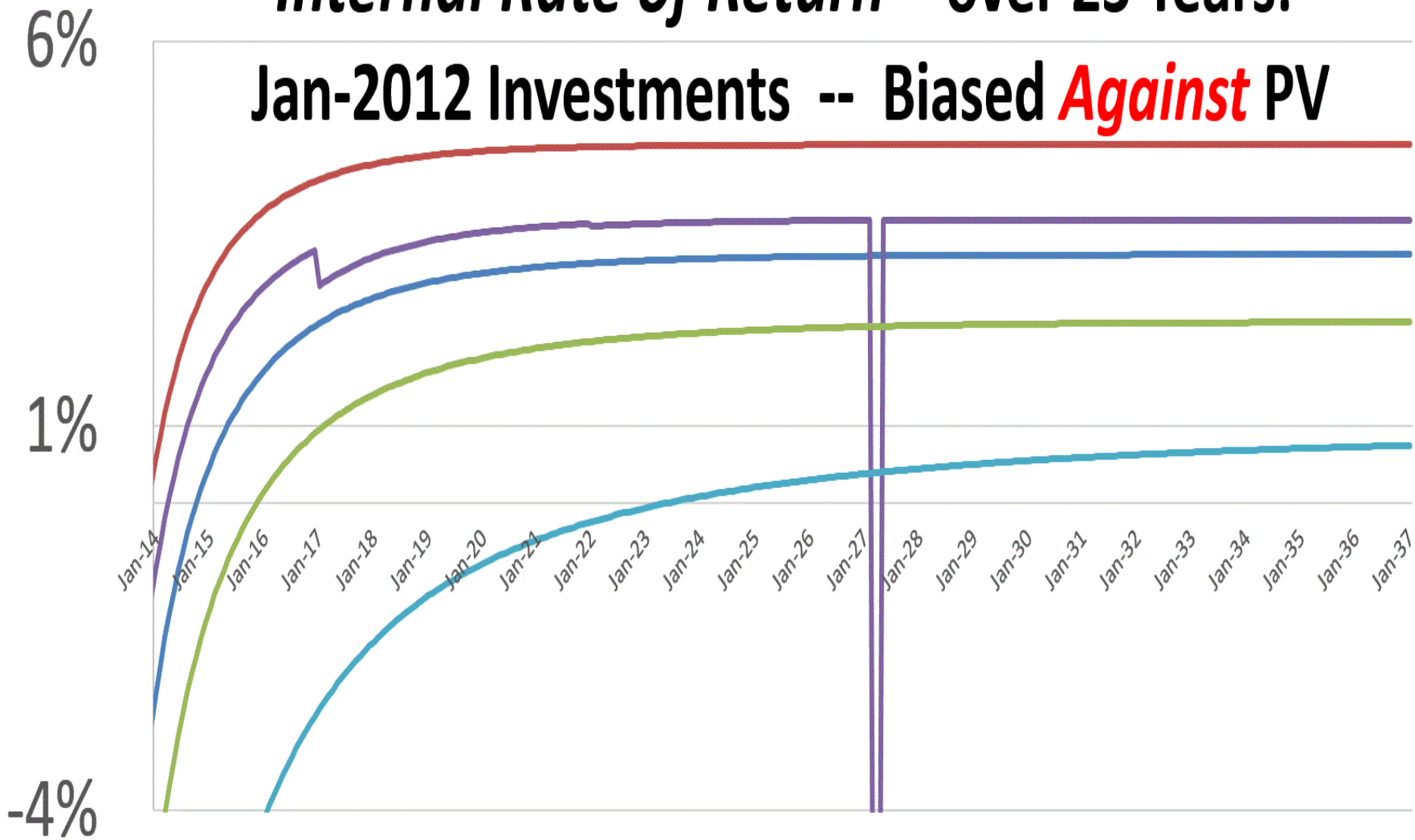

**Utility Disc** **Reliability** **IDCC** **V2G - Regulation** **PV**

# **PV has Decreasing Marginal Value**

Marginal value decreases as penetration increases

Penetration affects PV more than WIND

PV energy displaces the cleanest energy

Utilities curtail PV at high PV penetration

Curtailment varies inversely utility flexibility

Utilities often use spinning reserve to accommodate unexpected or projected drop in supply from RE;

this results in major energy conservation losses

Battery storage ameliorates these problems

Battery storage is best if grid-operator controlled

If PV penetration  $< 10\%$ , no problem for utilities

Renewable energy provides 16.3% of US installed electrical generation capacity:

- 8.57% hydro
- 5.26% wind
- 1.37% biomass
- 0.75% solar, and
- 0.33% geothermal steam.

Generation per MW of capacity for renewables is often lower than that for fossil fuels and nuclear power. Actual net electrical generation from renewable energy sources in the US now totals about 14% of total US production (5/14).



# Decoupling



## World's Best Window Co.

Series "2000"  
Casement

Vinyl Clad Wood Frame  
Double Glazing • Argon Fill • Low E  
ABC-X-1-00001-00001

### ENERGY PERFORMANCE RATINGS

U-Factor (U.S. / I-P)

**0.35**

Solar Heat Gain Coefficient

**0.32**

### ADDITIONAL PERFORMANCE RATINGS

Visible Transmittance

**0.51**

Air Leakage (U.S. / I-P)

**0.2**

Manufacturer stipulates that these ratings conform to applicable NFRC procedures for determining whole product performance. NFRC ratings are determined for a fixed set of environmental conditions and a specific product size. NFRC does not recommend any product and does not warrant the suitability of any product for any specific use. Consult manufacturer's literature for other product performance information.

[www.nfrc.org](http://www.nfrc.org)